



*Grandi Impianti*





**Tassinari Rubinetterie** opera nel settore della rubinetteria idraulica dal 1972, ampliando gradualmente e con continuità la propria esperienza e professionalità, selezionando i migliori prodotti presenti sul mercato e scegliendo le soluzioni più appropriate.

La nostra esperienza nel settore ci consente di soddisfare al meglio le richieste dei clienti e risolvere situazioni complicate, cercando di soddisfare ogni esigenza.

Specializzati in Rubinetteria Professionale dal settore Grandi Impianti, grande ristorazione, grande distribuzione, al settore sanitario.

La nostra gamma di articoli spazia dalla rubinetteria di alta qualità, dal design moderno ed elegante, al prodotto più competitivo.

#### **I Vostri vantaggi:**

- Nessun minimo d'ordine richiesto
- Spedizioni immediate
- Qualità Italiana
- Servizio di Dropshipping

Il nostro Staff specializzato è a Vostra disposizione per qualsiasi informazione ed eventuali offerte.



# INDICE

- GRUPPI DOCCIA PRELAVAGGIO STOVIGLIE - Su banco - **Pagina 03**
- GRUPPI DOCCIA PRELAVAGGIO STOVIGLIE - SKY - su banco - **Pagina 07**
- GRUPPI DOCCIA PRELAVAGGIO STOVIGLIE - A muro - **Pagina 11**
- GRUPPI DOCCIA PRELAVAGGIO STOVIGLIE - Misure ridotte - **Pagina 15**
- GRUPPI DOCCIA PRELAVAGGIO STOVIGLIE - MOLLY - **Pagina 20**
- GRUPPI DOCCIA PRELAVAGGIO STOVIGLIE - Ricambi - **Pagina 21**
  
- RUBINETTERIA PROFESSIONALE - **Pagina 27**
- RUBINETTERIA PROFESSIONALE - A muro - **Pagina 35**
- RUBINETTERIA PROFESSIONALE - Con doccia estraibile - **Pagina 38**
- RUBINETTERIA PROFESSIONALE - Colonnine - **Pagina 40**
- RUBINETTERIA PROFESSIONALE - Sottofinestra - **Pagina 41**
- RUBINETTERIA PROFESSIONALE - 3 Vie - **Pagina 42**
- RUBINETTERIA PROFESSIONALE - 5 Vie - **Pagina 43**
- RUBINETTERIA PROFESSIONALE - Distributori acqua - **Pagina 44**
- RUBINETTERIA PROFESSIONALE - Per laboratori - **Pagina 45**
- RUBINETTERIA PROFESSIONALE - Lavaocchi - **Pagina 46**
- RUBINETTERIA PROFESSIONALE - In acciaio inox - **Pagina 47**
- RUBINETTERIA PROFESSIONALE - Fotocellula - **Pagina 48**
- RUBINETTERIA PROFESSIONALE - Temporizzata - **Pagina 50**
- RUBINETTERIA PROFESSIONALE - Ricambi - **Pagina 51**
  
- RUBINETTERIA A PEDALE - **Pagina 57**
  
- RUBINETTERIA A GINOCCHIO - **Pagina 62**
  
- BOCCHIE DI EROGAZIONE - **Pagina 63**
  
- DOCCE DA FORNO E DA BANCO - **Pagina 65**
  
- SIFONI & PILETTE - **Pagina 67**
  
- AVVOLGITUBI E PISTOLE - **Pagina 70**
  
- RUBINETTI DI SCARICO - **Pagina 72**
  
- GRUPPI DI SICUREZZA PER VAPORE - **Pagina 74**
  
- TUBI CARICO - **Pagina 75**
  
- TUBI SCARICO - **Pagina 79**
  
- FLESSIBILI PER ACQUA - **Pagina 81**

# INDICE

- TUBI GAS - **Pagina 84**
- FLESSIBILI CONICI PER MACCHINE DEL CAFFE' - **Pagina 86**
- PATTUMIERE ACCIAIO INOX - **Pagina 87**
- TRAMOGGE ACCIAIO INOX - **Pagina 88**
- CARRELLI ACCIAIO INOX - **Pagina 89**
- LAVAMANI ACCIAIO INOX - **Pagina 90**
- RICAMBI PER LAVAMANI - **Pagina 94**
- ACCESSORI PER LAVAMANI - **Pagina 95**
- ARTICOLI IDRAULICI - **Pagina 98**
- ARTICOLI GAS - **Pagina 102**
- RACCORDERIA - **Pagina 104**

# GRUPPI DOCCIA PRELAVAGGIO STOVIGLIE SU BANCO STAR



Cod. 0067

Gruppo doccia + Monoforo



Cod. 0068

Gruppo doccia + Rub. a  
metà tubo + Monoforo



Cod. 3109

Gruppo doccia + Rub. a metà  
tubo + Miscelatore con leva  
cm. 20



Cod. 2900

Gruppo doccia  
+ Miscelatore con leva cm. 20

# GRUPPI DOCCIA PRELAVAGGIO STOVIGLIE SU BANCO STAR



Cod. 3055

Gruppo doccia + Miscelatore GIOVE con deviatore, canna fusa cm. 30 e leva in plastica nera cm. 30



Interasse  
cm. 15,5

Gruppo doccia + Biforo con canna fusa cm. 30 e leva in plastica nera cm. 30

Cod. 3110\_1/2  
Attacchi da 1/2"

Cod. 3110\_3/4  
Attacchi da 3/4"

# GRUPPI DOCCIA PRELAVAGGIO STOVIGLIE SU BANCO STAR



Interasse  
cm. 16

Gruppo doccia + Biforo

Cod. 3816\_1/2  
Attacchi da 1/2"

Cod. 3816\_3/4  
Attacchi da 3/4"



Interasse  
cm. 16

Gruppo doccia + Biforo  
+ Rub. a metà tubo

Cod. 3817\_1/2  
Attacchi da 1/2"

Cod. 3817\_3/4  
Attacchi da 3/4"



Cod. 3805

Gruppo doccia +  
Biforo con deviatore  
laterale



Cod. 3057

Gruppo doccia + Rubinetto  
singolo



Cod. 3826

Gruppo doccia + Rub. a metà  
tubo + Rubinetto singolo



Cod. 3803

Gruppo doccia +  
Miscelatore

# GRUPPI DOCCIA PRELAVAGGIO STOVIGLIE SU BANCO STAR



Cod. 0086

Gruppo doccia + Deviatore  
con canna cm. 30 +  
Monoforo



Interasse  
cm. 16

Gruppo doccia +  
Deviatore con canna  
cm. 30 + Biforo

Cod. 3818 1/2  
Attacchi da 1/2"

Cod. 3818 3/4  
Attacchi da 3/4"



Cod. 3572

Gruppo doccia + Deviatore  
con canna cm. 30  
+ Miscelatore con leva cm. 20



Cod. 4558

Gruppo doccia + Borchia di fissaggio al piano  
(per utilizzo con comando a pedale)



Cod. 4559

Gruppo doccia + Rub. a metà tubo +  
Borchia di fissaggio al piano  
(per utilizzo con comando a pedale)



# GRUPPI DOCCIA PRELAVAGGIO STOVIGLIE SU BANCO SKY



Cod. 4458

Gruppo doccia Sky  
+ Monofofo



Cod. 4458/LV

Gruppo doccia Sky + Monofofo  
con levetta 1/4 di giro



Cod. 4531

Gruppo doccia Sky  
+ Rub. a metà tubo  
+ Monofofo



Cod. 4531/LV

Gruppo doccia Sky + Rub.  
a metà tubo + Monofofo  
con levetta 1/4 di giro



Cod. 4536

Gruppo doccia Sky +  
Miscelatore con leva cm. 20

Cod. 4536/LC

Come sopra con leva corta



Cod. 4537

Gruppo doccia Sky + Rub. a  
metà + Miscelatore con leva  
cm. 20

Cod. 4537/LC

Come sopra con leva corta

# GRUPPI DOCCIA PRELAVAGGIO STOVIGLIE SU BANCO SKY



Cod. 4872

Gruppo doccia Sky + Rub. a metà tubo canna superiore cm. 30 + Miscelatore Tornado con leva in plastica nera cm. 23,70

Cod. 4872/LC20

Come sopra con leva clinica cm. 20 cromata

Cod. 4872/LC

Come sopra con leva corta cromata



Cod. 4538

Gruppo doccia Sky + Miscelatore con dev. con canna a tubo e leva in plastica nera cm. 23,7



Interasse  
cm. 15,5

Gruppo doccia Sky + Biforo con canna a tubo e leva in plastica nera cm. 30

Cod. 4744\_1/2  
Attacchi da 1/2"

Cod. 4744\_3/4  
Attacchi da 3/4"

# GRUPPI DOCCIA PRELAVAGGIO STOVIGLIE SU BANCO SKY



Cod. 4811

Gruppo doccia Sky + Borchia di  
fissaggio al piano  
**(per utilizzo con comando a pedale)**



Cod. 4751

Gruppo doccia Sky + Rub. a metà tubo  
+ Borchia di fissaggio al piano  
**(per utilizzo con comando a pedale)**



Interasse  
cm. 16

Gruppo doccia Sky + Biforo  
con levette 1/4 di giro

Cod. 3816\_1/2LV  
Attacchi da 1/2"

Cod. 3816\_3/4LV  
Attacchi da 3/4"



Interasse  
cm. 16

Gruppo doccia Sky + Rub. a  
metà tubo + Biforo con  
levette 1/4 di giro

Cod. 3817\_1/2LV  
Attacchi da 1/2"

Cod. 3817\_3/4LV  
Attacchi da 3/4"

# GRUPPI DOCCIA PRELAVAGGIO STOVIGLIE SU BANCO TORNADO



Cod. 4878

Gruppo doccia Sky +  
Miscelatore TORNADO con  
dev. leva in plastica nera  
cm. 23,7 e canna cm 30



Cod. 4877

Gruppo doccia MINI +  
Miscelatore TORNADO con  
leva in plastica nera cm.  
23,7 e canna cm. 30

# GRUPPI DOCCIA PRELAVAGGIO STOVIGLIE A MURO



Interasse  
cm. 14,5 +/- 10

**Cod. 3532**

Gruppo doccia +  
Miscelatore a muro con  
leva in plastica nera cm.  
23,70 e canna fusa  
superiore cm. 30



Interasse cm. 13/17

**Cod. 2903**

Gruppo doccia +  
Miscelatore a muro leva  
clinica cm. 20



Interasse  
cm. 13/17

**Cod. 2904**

Gruppo doccia + Deviatore  
+ Miscelatore a muro leva  
clinica cm. 20



Interasse  
cm. 13/17

**Cod. 5017**

Gruppo doccia a muro  
con gruppo biforo +  
Deviatore con canna  
parallela cm. 30



Interasse  
cm. 13/17

**Cod. 0070**

Gruppo doccia + Gruppo  
lavello a muro



Interasse  
cm. 13/17

**Cod. 0070RM**

Gruppo doccia + Rub. a  
metà tubo + Gruppo  
lavello a muro

# GRUPPI DOCCIA PRELAVAGGIO STOVIGLIE A MURO



Interasse  
cm. 13/17

Cod. 0070SKLV

Gruppo doccia Sky  
+ Gruppo lavello a muro  
con levette 1/4 di giro



Interasse  
cm. 13/17

Cod. 0070RMLV

Gruppo doccia Sky  
+ Rub. a metà tubo  
+ Gruppo lavello a muro  
con levette 1/4 di giro



Cod. 3058

Gruppo doccia +  
Rubinetto singolo a muro



Cod. 3541

Gruppo doccia + Rub. a metà  
tubo + Rubinetto singolo a  
muro

# GRUPPI DOCCIA PRELAVAGGIO STOVIGLIE A MURO

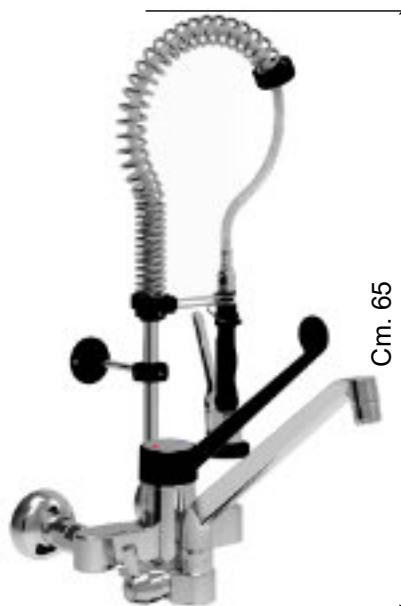

Interasse  
cm. 14,5 +/- 10

**Cod. 5055**

Gruppo doccia MIGNON +  
Miscelatore a muro con leva  
in plastica nera cm. 23,7

**Cod. 5055/LC20**

Come sopra con leva clinica  
cm. 20



Interasse  
cm. 14,5 +/- 10

**Cod. 5019**

Gruppo doccia MINI  
con miscelatore a muro  
canna cm. 30 leva in  
plastica nera cm. 23,7

**Cod. 5019LC20**

Gruppo doccia MINI con  
miscelatore a muro  
canna cm. 30 e leva  
cromata cm. 20

**Cod. 5019LCC20**

Gruppo doccia MINI con  
miscelatore a muro  
canna cm. 20 e leva  
cromata cm. 20



Interasse  
cm. 13/17

**Cod. 5068**

Gruppo doccia  
MIGNON con gruppo  
biforo + Deviatore con  
canna parallela cm. 30



Interasse  
cm. 13/17

**Cod. 5003**

Gruppo doccia MIGNON  
+ Rub. a metà tubo  
+ Gruppo lavello a muro

# GRUPPI DOCCIA PRELAVAGGIO STOVIGLIE A MURO



Cod. 4863

Gruppo doccia MINI +  
Miscelatore a muro con  
leva corta

Interasse  
cm. 13/17



Cod. 5006

Gruppo doccia MINI + Rub. a  
metà tubo + Miscelatore a  
muro leva corta

Interasse  
cm. 13/17



Cod. 4863/LC20

Gruppo doccia MINI +  
Miscelatore a muro con  
leva clinica cm. 20

Interasse  
cm. 13/17



Cod. 4862

Gruppo doccia MINI  
+ Gruppo biforo a  
muro due pomoli

Interasse  
cm. 13/17



# GRUPPI DOCCIA PRELAVAGGIO STOVIGLIE MISURE RIDOTTE

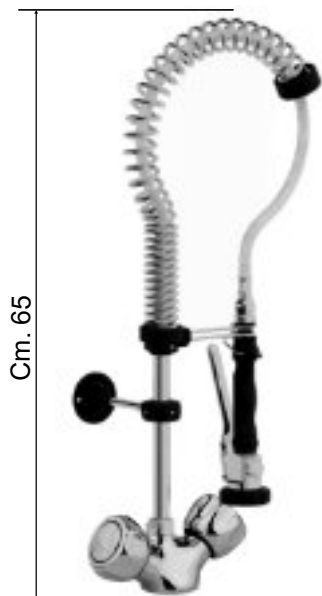

Cod. 4562

Gruppo doccia MIGNON +  
Monoforo

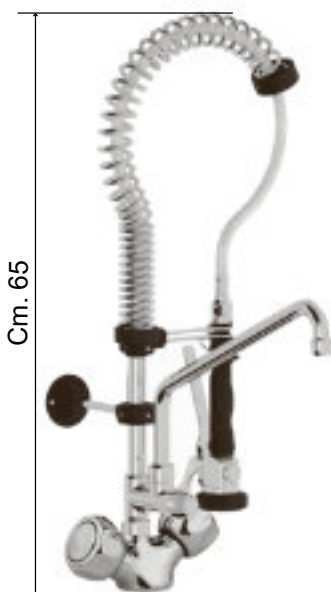

Cod. 4563

Gruppo doccia  
MIGNON + Rub. a  
metà tubo + Monoforo



Cod. 4564

Gruppo doccia MIGNON +  
Miscelatore con leva cm. 20

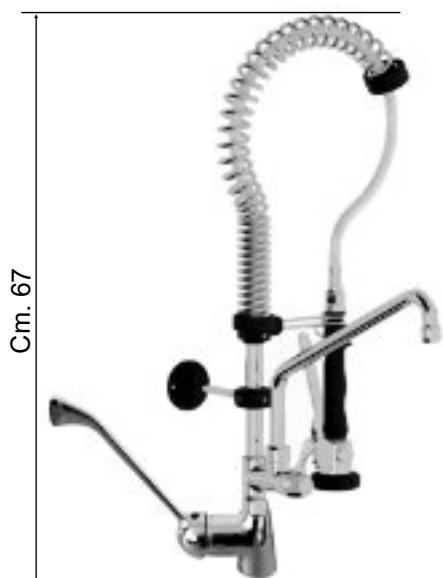

Cod. 4565

Gruppo doccia MIGNON +  
Rub. a metà tubo +  
Miscelatore con leva cm. 20

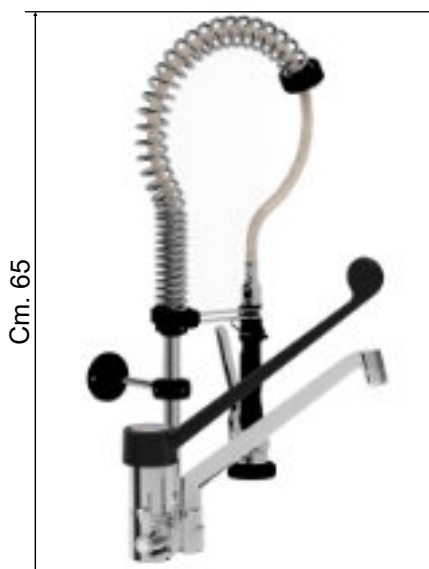

Cod. 5015

Gruppo doccia MIGNON +  
Miscelatore GIOVE con  
dev. canna fusa e leva in  
plastica nera cm. 30

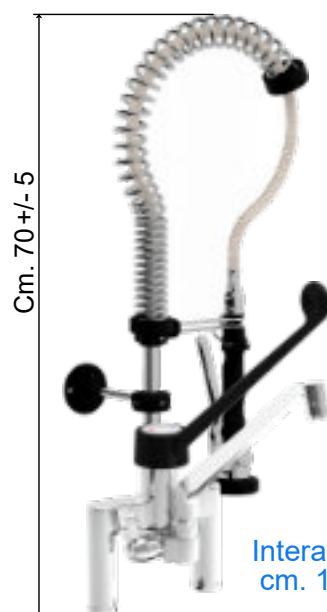

Interasse  
cm. 15,5

Cod. 5054\_1/2  
Attacchi da 1/2"

Cod. 5054\_3/4  
Attacchi da 3/4"

# GRUPPI DOCCIA PRELAVAGGIO STOVIGLIE MISURE RIDOTTE **H. 50 CM.**



Cod. 4839

Gruppo doccia MINI  
+ Rub. a metà tubo  
+ Miscelatore leva corta



Cod. 4847

Gruppo doccia MINI +  
Miscelatore a leva corta



Cod. 5018

Gruppo doccia MINI +  
Miscelatore con dev. con  
canna a tubo e leva pl.  
cm. 23,7

Cod. 5018/40

Gruppo doccia MINI +  
Miscelatore con dev. con  
canna cm. 40 e leva pl.  
cm. 23,7

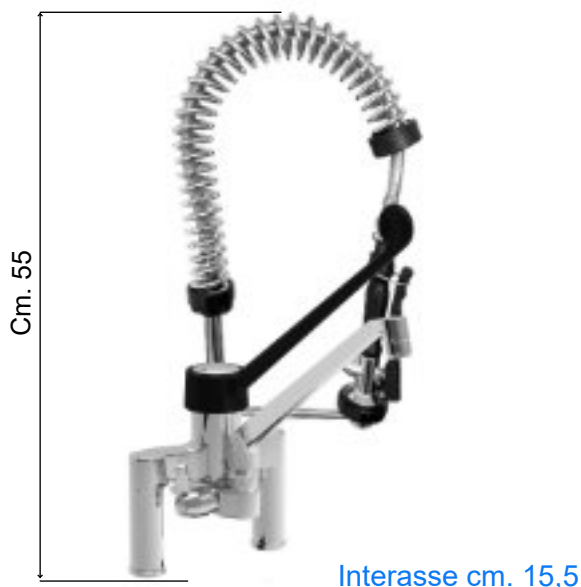

Gruppo doccia MINI +  
Biforo leva clinica cm. 30

Cod. 5023\_1/2  
Attacchi da 1/2"

Cod. 5023\_3/4  
Attacchi da 3/4"



Cod. 4877

Gruppo doccia MINI +  
Miscelatore TORNADO  
con leva in plastica nera e  
canna cm. 30



Cod. 5042

Gruppo doccia MINI  
+ Rub. a metà tubo  
+ Rubinetto singolo (solo  
acqua fredda)

# GRUPPI DOCCIA PRELAVAGGIO STOVIGLIE MISURE RIDOTTE

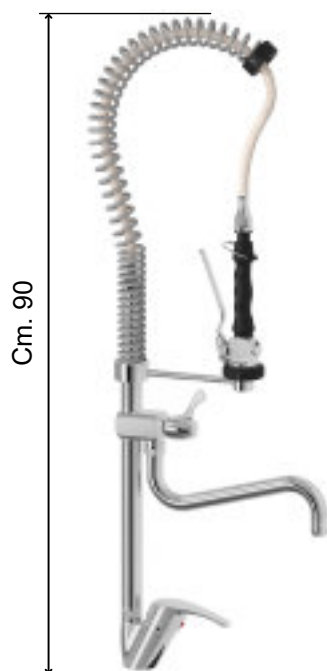

Cod. 3107

Gruppo doccia Jolly



Cod. 4466

Gruppo doccia mini  
professionale con miscelatore  
leva corta



Cod. 0176

Miscelatore lavello  
SATURNO  
H. Tot. cm. 40



Cod. 3220

Miscelatore lavello  
PROFESSIONAL con  
doccetta tonda



Cod. 4965

Miscelatore con doccia  
K2

# GRUPPI DOCCIA PRELAVAGGIO STOVIGLIE MISURE RIDOTTE



Cm. 61

Cod. 4465

Doccione mini professionale con leva cm. 20 e doccia estraibile



Cm. 65

Cod. 4262

Gruppo doccia MIGNON + Borchia di fissaggio al piano (per utilizzo con comando a pedale)



Cm. 50

Cod. 5007

Gruppo doccia MINI + Borchia di fissaggio al piano (per utilizzo con comando a pedale)



Cm. 61

Cod. 4464

Doccione mini professionale leva corta doccia estraibile



Cm. 65

Cod. 4263

Gruppo doccia MIGNON + Rub. a metà + Borchia di fissaggio al piano (per utilizzo con comando a pedale)

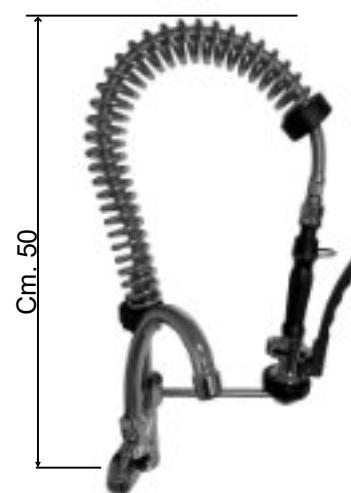

Cm. 50

Cod. 5004

Gruppo doccia MINI + Rub. a metà tubo + Borchia di fissaggio al piano (per utilizzo con comando a pedale)

# GRUPPI DOCCIA PRELAVAGGIO STOVIGLIE MISURE RIDOTTE



Cod. 4562/LV

Gruppo doccia SKY  
MIGNON + Monoforo con  
levetta 1/4 di giro



Cod. 4563/LV

Gruppo doccia SKY MIGNON +  
Rub. a metà tubo + Monoforo con  
levetta 1/4 di giro

# GRUPPI DOCCIA PRELAVAGGIO STOVIGLIE MOLLY



Cod. 4960

Gruppo doccia Molly +  
Monoforo



Cod. 4962

Gruppo doccia Molly + Rub. a  
metà tubo + Monoforo



Cod. 4961

Gruppo doccia Molly +  
Miscelatore a leva



Cod. 4963

Gruppo doccia Molly + Rub. a  
metà tubo + Miscelatore a leva

# GRUPPI DOCCIA PRELAVAGGIO STOVIGLIE

## RICAMBI



Cod. 0076

Corpo doccia da 1/2" STAR  
(Modello in dotazione nei  
gruppi doccia STAR)



Cod. 4566

Corpo doccia da 1/2" SKY  
(Modello in dotazione nei gruppi  
doccia SKY)

Cod. 4566/M

Corpo doccia per Gruppo  
doccia Mini



Cod. 5059

Corpo doccia in  
**acciaio inox** da 1/2"



**Tubo supporto doccia**

Cod. 0077 - cm. 75

Cod. 0078 - cm. 62

Cod. 0079 - cm. 75 + Rub. a metà tubo + Canna

Cod. 0079/CU - cm. 75 + Rub. a metà tubo + Canna a  
ponte cm. 30

Cod. 4733 - cm. 21 - per gruppi MINI + Rub. a metà +  
canna

Cod. 4857 - cm 21 - per gruppi MINI

Cod. RIC4499 - cm. 31 - per gruppi MIGNON (nuovi modelli  
2020)

Cod. RIC4498 - cm. 31 - per gruppi MIGNON + Rub. a  
metà + Canna (nuovi modelli 2020)



Cod. 3551

Staffa completa per Gruppi  
Doccia e Gruppi Mignon



Cod. RIC4500

Staffa a muro lunga cm. 50 (solo il  
pezzo dal tubo al muro)

Cod. 4411

Staffa per fissaggio a muro gruppo  
doccia Jolly

# GRUPPI DOCCIA PRELAVAGGIO STOVIGLIE RICAMBI



## Molla di bilanciamento

**cod. 0080** - per gruppi doccia

**cod. 0080/MN** - per gruppi MINI

**cod. 0080/SM** - per gruppi MIGNON (nuovi modelli 2020)

**cod. 0080/MGN** - per gruppi doccia MIGNON (vecchi modelli)

**cod. 0080/INOX** - in acciaio inox AISI 304



**Cod. 0090**  
Deviatore +  
Canna cm. 30



**Cod. LEVET000849**  
Levetta per  
deviatore miscelatori



Vitone per rubinetto a  
metà tubo, deviatore e  
monoforo 3544LV

**Cod. RIC4414**  
Vitone A.F.

**Cod. RIC4414/R**  
Vitone A.C.



**Cod. RIC4422**  
Levetta per  
rubinetto a  
metà tubo



**Cod. 0082**

Flessibile inox viplato cm. 110 con attacco  
girevole **(in dotazione gruppi doccia)**



**Cod. 4435**

Flessibile acciaio inox cm. 110



## Flessibile Viplato con attacco girevole

**cod. 4818** - cm. 55  
**cod. RIC4643** - cm. 70  
**cod. 0066** - cm. 80  
**cod. 0082** - cm. 110  
**cod. 0069** - cm. 120  
**cod. 0072** - cm. 150  
**cod. 0074** - cm. 200  
**cod. 3047** - cm. 300



**Cod. RIC4508**  
Canna tubo a "S" cm. 25  
per rub. a metà tubo



# GRUPPI DOCCIA PRELAVAGGIO STOVIGLIE RICAMBI



**Cod. 2334**

Cartuccia Ø 40 alta  
(modelli dal 2015) per  
cod. 3055 - 3110 -  
3532 - 4872 - 4878



**Cod. 2943**

Cartuccia (vecchio  
modello) per cod. 3055 -  
3110 - 3532



**Cod. 0136**

Cartuccia bassa Ø 40



**Cod. 0171**

Cartuccia alta Ø 40  
per cod. 2900 - 3109



**Cod. 0174**

Leva cm. 20 chiusa



**Cod. 2949**

Leva in plastica nera  
cm. 30 per codice  
3055 - 3110 - 4744  
**(Nuovo Modello)**



**Cod. RIC0150**

Leva in plastica Nera  
cm. 23,70 per codice  
4878 - 4877 - 4872 -  
4538



**Cod. 3544LV**

Monoforo con levetta  
1/4 di giro senza  
canna



**Cod. RIC4413**

Vitone ricambio per  
**gruppi doccia**



Maniglia cromata per  
monoforo

**Cod. RIC4412**

con cerchietto rosso

**Cod. RIC4412/B**

con cerchietto blu



**Cod. 3544**

Monoforo senza  
canna per **gruppi  
doccia**



**Cod. 3067**

Miscelatore senza  
canna con leva  
cm. 20 per  
**gruppi doccia**



**Cod. 1281**

Monoforo per  
**gruppi SKY**



**Cod. RIC4413IT**

Vitone ricambio  
per monoforo  
**gruppi SKY**



**Cod. RIC4638**

Maniglia per  
Monoforo **gruppi  
SKY**



Levetta per monoforo  
1/4 di giro

**Cod. RIC4410R** - A.C.

**Cod. RIC4410B** - A.F.

# GRUPPI DOCCIA PRELAVAGGIO STOVIGLIE RICAMBI

RICAMBIO



Cod. 0071  
Gruppo doccia

RICAMBIO



Cod. 3827  
Gruppo doccia con  
rubinetto a metà tubo



Cod. 3543  
Rubinetto  
verticale 1/2  
senza canna



Cod. 3005  
Borchia conica per  
fissaggio tubo doccia  
al piano

RICAMBIO



Cod. 3533  
Gruppo doccia MIGNON  
con rubinetto a metà tubo

RICAMBIO



Cod. 4567  
Gruppo doccia MIGNON



Cod. 4568  
Borchia per  
fissaggio tubo  
doccione al piano



Cod. 3545  
Gruppo a muro senza  
canna



Cod. 3044  
Miscelatore a muro  
con leva cm. 20 senza  
canna per attacco  
gruppo doccia



Biforo senza canna

Cod. 3546\_1/2  
Attacchi da 1/2"

Cod. 3546\_3/4  
Attacchi da 3/4"



Biforo senza canna con  
levette 1/4 di giro

Cod. 3546\_1/2LV  
Attacchi da 1/2"

Cod. 3546\_3/4LV  
Attacchi da 3/4"



Cod. RIC4427  
Rubinetto singolo a  
muro senza canna

# GRUPPI DOCCIA PRELAVAGGIO STOVIGLIE RICAMBI



**Cod. 3052**

Miscelatore GIOVE con deviatore per attacco gruppo doccia, canna fusa cm. 30 e leva in plastica nera cm 30



Biforo con deviatore per attacco gruppo doccia con canna fusa cm. 30 e leva in plastica nera cm. 30

**Cod. 0073\_1/2**  
Attacchi da 1/2"

**Cod. 0073\_3/4**  
Attacchi da 3/4"



**Cod. 3052/TU**

Miscelatore con deviatore per attacco gruppo doccia con canna a tubo e leva plastica nera cm. 23,70



**Cod. 4879**

Miscelatore TORNADO con deviatore per attacco doccia con leva nera e canna cm. 30



Biforo con deviatore per attacco gruppo doccia con canna a tubo cm. 30 e leva in plastica nera cm. 30

**Cod. 0073/TU\_1/2**  
Attacchi da 1/2"

**Cod. 0073/TU\_3/4**  
Attacchi da 3/4"



Interasse cm. 14,5 +/- 10

**Cod. 3531**  
Miscelatore biforo a muro con deviatore per attacco gruppo doccia, con leva in plastica nera cm. 23,7 e canna superiore cm. 30



Interasse cm. 13/17

**Cod. 0101/NEW**

Gruppo a muro con deviatore per attacco gruppo doccia con canna cm. 30 NUOVO MODELLO

Per altri ricambi particolari consigliamo di chiedere esploso dettagliato.

# GRUPPI DOCCIA PRELAVAGGIO STOVIGLIE RICAMBI



Cod. 3806

Biforo con deviatore laterale per gruppo doccia cod. 3805



Cod. 3804

Miscelatore + deviatore e att. doccia con canna cm. 35 e leva cm. 32  
Per gruppo doccia cod. 3803



Cod. RIC4561  
Flessibile viplato cm. 110 per gruppi doccia RIVER

Cod. RIC4606  
Flessibile viplato cm. 60 per gruppo doccia cod. 4466



Cod. RIC1014  
Corpo doccia CLASSIC per gruppi doccia RIVER

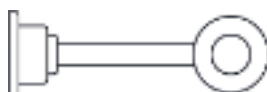

Cod. RIC4602A  
Staffa per fissaggio a muro per gruppo doccia RIVER



Cod. RIC4602B  
Staffa a forcella per gruppo doccia RIVER



Cod. RIC4625  
Molla di supporto doccia prelavaggio colore grigio RIVER



Cod. 0109  
Leva in plastica grigia cm. 32 (per cod. 3805-3806-3803-3804)

Cod. RIC4602C  
Supporto ABS grigio della molla RIVER



Cod. RIC4587  
Vitone in dischi ceramici per deviatore gruppo doccia RIVER cod. 3805



Canna YOTA - D.20

Cod. RIC4529 - cm. 20 (per cod. 4466)

Cod. RIC4530 - cm. 30 (per cod. 3805-3806-3803-3804-2901)



Cod. RIC4588  
Levetta per deviatore gruppo doccia RIVER (3805)

# Rubineria Professionale



**Cod. 3051**

Miscelatore GIOVE con canna fusa lunga e leva in plastica nera cm 30



**Cod. 3059**

Miscelatore GIOVE con canna fusa cm 25 e leva in plastica nera cm 30



**Interasse cm. 15,5**

Biforo leva clinica, con canna fusa cm. 30 e leva in plastica nera cm. 30

**Cod. 0026\_1/2**  
Attacchi da 1/2"

**Cod. 0026\_3/4**  
Attacchi da 3/4"



**Cod. 3048**

Miscelatore MARTE con canna lunga e leva in plastica nera cm. 23,7



**Cod. 4480**

Miscelatore MARTE con canna cm. 25 e leva in plastica nera cm. 23,7



**Codice 3048/40**

Miscelatore MARTE canna lunga cm. 40 leva in plastica nera cm. 23,7



**Codice 4875**

Miscelatore TORNADO con leva plastica nera cm. 23,7 e canna cm. 30



**Codice 4870**

Miscelatore TORNADO con leva plastica nera cm. 23,7 e canna cm. 26

**Codice 4870/LC20**

Miscelatore TORNADO leva clinica metallo cm. 20 e canna cm. 26

**Codice 4870/LC**

Miscelatore TORNADO LEVA CORTA metallo e canna cm. 26

# Rubinetteria Professionale



**Cod. 4802**  
 Miscelatore per lavello  
 professionale leva clinica  
 canna h. cm. 36 L. cm. 25

**Cod. 4806**  
 Miscelatore per lavello  
 professionale leva clinica  
 canna h. cm. 40 L. cm. 30

**Cod. 4837**  
 Miscelatore per lavello  
 professionale leva clinica  
 canna h. 36 x l. cm. 50



**Cod. 4801**  
 Miscelatore per lavello  
 professionale leva corta  
 canna h. cm. 36 L. cm. 25

**Cod. 4805**  
 Miscelatore per lavello  
 professionale leva corta  
 canna h. cm. 40 L. cm. 30



**Cod. 4860**  
 Miscelatore lavello industriale  
 canna lunga cm 30 e leva in  
 plastica cm. 30



**Cod. 3051/TU**  
 Miscelatore GIOVE con  
 canna a tubo lunga e leva in  
 plastica nera cm 30



**Cod. 3059/TU**  
 Miscelatore GIOVE con  
 canna a tubo cm. 25 e leva in  
 plastica nera cm 30



**Interasse cm. 15,5**  
 Biforo leva clinica, con canna  
 a tubo cm. 30 e leva in  
 plastica nera cm. 30

**Cod. 0026\_1/2TU**  
 Attacchi da 1/2"

**Cod. 0026\_3/4TU**  
 Attacchi da 3/4"

# Rubinetteria Professionale



Miscelatore con leva in plastica grigia canna alta

- Cod. 3819 - canna h. 34 x L. 25
- Cod. 3820 - canna h. 39 x L. 30
- Cod. 3821 - canna h. 43 x L. 35



Cod. 2901

Miscelatore canna cm. 35 e leva cm. 32 in plastica grigia



Cod. 2902

Miscelatore con leva cm. 27 in plastica grigia



Cod. 0083

Miscelatore con canna cm. 30  
leva cm. 20

# Rubinetteria Professionale



Cod. 0120

Miscelatore lavello con leva cm. 20



Cod. 4729

Miscelatore lavello con leva in plastica grigia cm. 30



Cod. 3024

Miscelatore lavello con leva cm. 20



Cod. 3072

Miscelatore lavello con leva cm. 20



Cod. 3072/LP

Miscelatore lavello con leva in plastica grigia cm. 30



Cod. 0100

Miscelatore lavello con leva corta



Cod. 3025

Miscelatore lavello con leva corta



Cod. 3071

Miscelatore lavello con leva corta



# Rubinetteria Professionale



Cod. 4871

Miscelatore TORNADO con  
leva corta e canna cigno cm. 15



Cod. 0287

Miscelatore lavello canna alta  
quadra



Cod. 0297

Miscelatore lavello canna alta



Cod. 0284

Miscelatore lavello canna alta  
quadra con leva cm. 20



Cod. 3217

Miscelatore lavello canna alta



Cod. 3325

Miscelatore lavello SALT con  
certificazione americana NSF61



Cod. 4907

Miscelatore lavello  
PITAGORA



Cod. 3070

Miscelatore lavello canna  
alta

# Rubineria Professionale



Cod. 0165

Miscelatore lavabo T/C  
con leva cm. 20



Cod. 3198

Miscelatore lavabo T/C con  
leva corta



Cod. 3199

Miscelatore lavabo T/C  
STICK



Cod. 3060

Miscelatore lavello leva  
cm. 20 e canna corta



Cod. 3061

Miscelatore lavello leva  
corta e canna corta



Cod. 3065

Miscelatore lavello  
con corpo Ø mm. 42  
con leva cm. 20



Cod. 0127

Monoforo con canna  
fusa cm. 20

Cod. 0127/30

Monoforo con canna  
fusa cm. 30



Cod. 4575

Colonna bar 1/2"



Cod. 4913

Colonnina MINIMAL  
h. Tot. cm. 20,5



Cod. 6112

Rubinetto monoacqua  
PILLAR

# Rubinetteria Professionale



cm 30

Interasse cm. 16

Gruppo Biforo con canna  
cm. 30

Cod. 0019\_1/2  
Attacchi da 1/2"

Cod. 0019\_3/4  
Attacchi da 3/4"



Cod. 0105

Monoforo con canna  
cm. 30

Cod. 0105/15  
Come sopra con canna  
cm. 15 parallela

Cod. 0105/20  
Come sopra con canna  
cm. 20



Cm. 30

Cod. 0116

Rubinetto verticale 1/2" con  
canna a "U" da cm. 30

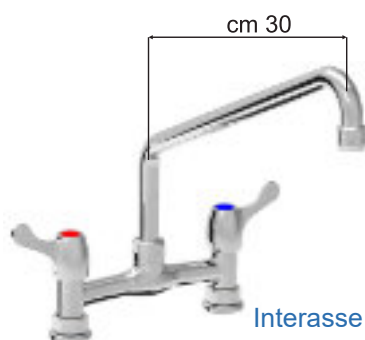

cm 30

Interasse cm. 16

Gruppo Biforo con canna  
cm. 30 con levette 1/4 di  
giro

Cod. 0019\_1/2LV  
Attacchi da 1/2"

Cod. 0019\_3/4LV  
Attacchi da 3/4"

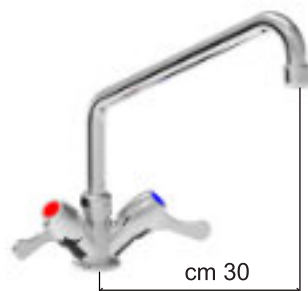

cm 30

Cod. 0105LV

Monoforo con levette 1/4  
di giro, con canna cm. 30



Cod. 0105LVCN

Monoforo con levette 1/4 di  
giro, con canna cm. 30, CON  
CANNETTE RIGIDE - alta  
temperatura



cm 30

Cod. 0116LV

Rubinetto verticale 1/2"  
con canna a "U" da cm.  
30 con levetta 1/4 di giro



Cod. 3504

Rubinetto Monoforo canna  
corta con maniglia atermica  
nera



Cm. 40

Cod. 3505

Rubinetto Monoforo con  
canna cm.40 con maniglia  
atermica nera

# Rubineria Professionale



Cod. 4569

Rubinetto incasso 1/2"

Cod. 4570

Rubinetto incasso 1/2" con maniglia atermica nera



Cod. 4473

Rubinetto arresto ad angolo DX 1/2" maniglia atermica nera

Cod. 4472

Rubinetto arresto ad angolo SX 1/2" maniglia atermica nera



Cod. 4569/LV

Rubinetto incasso 1/2" con levetta 1/4 di giro



Cod. 4576

Rubinetto collo cigno 1/2" con leva lunga



Cod. 4497

Rubinetto incasso 1/2" con maniglia a croce con tappino rosso



Cod. RIC4564

Dado di fissaggio per rubinetto incasso cod. 4569 mm. 27x19



Cod. 4555

Dado mm. 26x19 per fissaggio rub. di arresto per cod. 4570



Cod. 4698

Rubinetto collo cigno 1/2"



Cod. 0116/CR

Rubinetto verticale 1/2" con canna di riempimento



Cod. 0115

Erogatore di riempimento con getto snodabile



Cod. 4476

Erogatore fisso M. 1/2"



Cod. 4481

Erogatore di riempimento fisso mm. 30x29 M. 1/2"

# Rubinetteria Professionale A MURO



Interasse cm. 14,5 +/- 10

**Cod. 3530**

Miscelatore biforo a muro leva in plastica nera cm. 23,7 e canna superiore cm. 30



Interasse cm. 14,5 +/- 10

**Cod. 3529**

Miscelatore lavello a muro con leva in plastica nera cm. 23,7 e canna cm.30



Interasse cm. 13/17

Miscelatore lavello a muro leva cm.20

**Cod. 3503** - con canna cm. 20

**Cod. 3542** - con canna cm. 30

**Cod. 3073** - con canna cm. 20



Interasse cm. 13/17

Miscelatore lavello a muro con leva in plastica nera cm. 23,7

**Cod. 3503/LP** - con canna cm. 20

**Cod. 3542/LP** - con canna cm. 30

# Rubinetteria Professionale A MURO

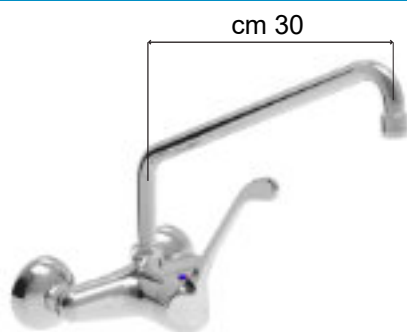

Interasse cm. 13/17

**Cod. 3043**

Miscelatore a muro con  
canna cm. 30 e leva cm. 20

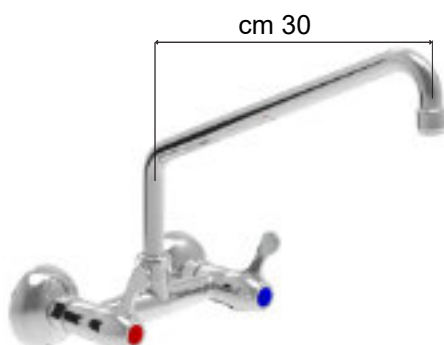

Interasse cm. 13/17

**Cod. 0102LV**

Gruppo a muro con canna  
cm. 30 con levette 1/4 di  
giro



Interasse cm. 13/17

Gruppo a muro

**Cod. 0102** - canna cm. 30

**Cod. 0102/20** - canna cm. 20

**Cod. 0102/40** - canna cm. 40



Interasse cm. 13/17

Gruppo a muro con canna  
parallela

**Cod. 0102P20** - canna cm. 20

**Cod. 0102P30** - canna cm. 30

**Cod. 0102P40** - canna cm. 40



Interasse cm. 13/17

**Cod. 0102/SI/LV**

Gruppo a muro con snodo  
inferiore a "S" cm. 20 con levetta  
1/4 di giro



Interasse cm. 13/17

**Cod. 0102/SI**

Gruppo a muro con  
snodo inferiore a "S"  
cm. 30



**Cod. 5032**

Rubinetto a muro doppio snodo cm. 80 1/2"  
(1 snodo cm. 40 + 1 snodo cm. 40)



**Cod. 0169/DS**

Rubinetto con leva clinica canna  
superiore con doppio snodo cm. 52

# Rubinetteria Professionale A MURO



**Cod. 0210**

Rubinetto con maniglia  
canna inferiore a "S" cm. 30



**Cod. 0210/MN**

Rubinetto con maniglia  
atermica nera e canna  
inferiore a "S" cm. 30



**Cod. 0168**

Rubinetto a muro con maniglia  
canna superiore cm. 30



**Cod. 0211**

Rubinetto con leva clinica  
canna inferiore a "S" cm. 30

**Cod. 0211/20** - Canna cm. 20

**Cod. 0211/40** - Canna cm. 40



**Cod. 4583**

Rubinetto marziano leva  
lunga



Rubinetto a muro con maniglia canna  
superiore PARALLELA

**Cod. 0168/P** - Canna cm. 30

**Cod. 0168/40** - Canna cm. 40

**Cod. 0168/50** - Canna cm. h. 30x L. 50

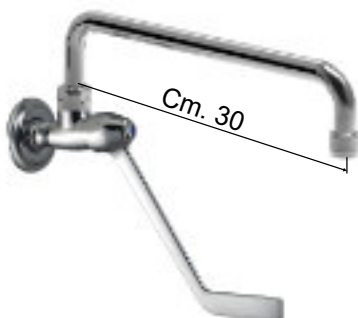

**Cod. 0169/P**

Rubinetto con leva clinica  
canna superiore cm. 30



**Cod. 0169**

Rubinetto con leva clinica  
canna superiore cm. 30



**Cod. 2393**

Rubinetto a muro con maniglia  
atermica con doppio snodo  
mm.650 ( 1 snodo mm. 400+1  
snodo mm. 250)

# Rubinetteria Professionale con Doccia Estraibile



Cod. 3108

Miscelatore lavello con doccia estraibile con leva cm.20

Cod. 3108/DM

Come sopra con doccia in metallo



Cod. 0111

Miscelatore lavello con doccia estraibile con leva corta

Cod. 0111/DM

Come sopra con doccia in metallo



Cod. 0112

Miscelatore lavello canna alta con doccia estraibile con leva corta



Cod. 0113

Miscelatore lavello canna alta con doccia estraibile con leva cm. 20



Cod. 3108/LP

Miscelatore lavello con doccia estraibile leva in plastica nera cm. 23,7



Cod. 3211

Miscelatore lavello con doccia estraibile e leva cm. 20

**Serie economica**



Cod. 3211/LP

Miscelatore lavello con doccia estraibile e leva in plastica cm. 30

**Serie economica**



Cod. 3069

Miscelatore lavello con doccia estraibile e leva corta

**Serie economica**



# Rubinetteria Professionale con Doccia Estraibile



Cod. 4577

Miscelatore con doccia estraibile  
canna alta



Cod. 3219

Miscelatore lavello GINGER con  
doccia estraibile



Cod. 3285

Miscelatore lavello canna alta  
cromato con doccia estraibile 2  
getti in metallo



Cod. 3345

Miscelatore con doccia  
estraibile termostatico canna  
alta



Cod. 4972

Miscelatore con doccino  
estraibile leva cm. 20



Cod. 0285

Miscelatore per parrucchieri

# Rubinetteria Professionale COLONNINE



Cod. 0084

Colonnina orientabile  
H. mm. 700 x mm. 420  
con canna cm. 25



Cod. 4493

Ghiera h. cm. 2  
per colonnina cod. 0084  
(per un migliore fissaggio)



Cod. RIC2923

Piastra in acciaio per  
rinforzo

Cod. RIC4421

Kit fissaggio per colonnina  
0084 (1 tronchetto zinc. 2 fil.  
1/2" x 30 + 1 manicotto 1/2"  
ottone giallo + 1 collare 1/2")



Cod. 3808

Colonnina orientabile  
con canna cm. 30



Cod. 4966

Monoforo montato su colonna  
doppio snodo con canna cm.  
40 + cm. 30. H. cm. 50



Cod. 3807

Monoforo montato su colonna  
H. cm. 63 con canna cm. 30

# Rubinetteria Professionale SOTTOFINESTRA



Cod. 3237

Miscelatore sottofinestra  
con leva cm. 20  
(ingombro max cm. 4)



Cod. 3238

Miscelatore sottofinestra con doccia  
estraibile con leva cm. 20  
(ingombro max cm. 5)



Cod. 0299

Miscelatore inclinabile per  
sottofinestra  
(ingombro max cm. 7,5)



Cod. 3322

Miscelatoreavello telescopico per  
sottofinestra altezza regolabile  
(ingombro max cm. 4,5)



Cod. 3322/D

Miscelatoreavello telescopico per  
sottofinestra altezza regolabile con  
doccia estraibile a 2 getti  
(ingombro max cm. 4,5)

# Rubinetteria Professionale

## MISCELATORI 3 VIE

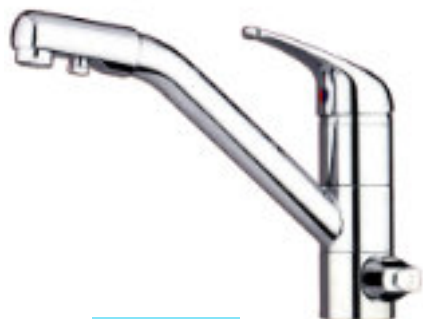

Cod. 3230

Miscelatore lavello con attacco 3 vie e 2 uscite



Cod. 3239

Miscelatore lavello canna alta con attacco 3 vie e 2 uscite



Cod. 6127

Miscelatore canna alta 3 vie con uscita separata



Cod. 6128

Miscelatore lavello 3 vie reclinabile per sottofinestra (ingombro max cm. 6,2)



Cod. 6130

Miscelatore 3 vie con uscita delle acque separata e mollone



Cod. 4982

Erogatore professionale 3 vie a comando meccanico



Cod. 6129

Miscelatore lavello 3 vie con doccia estraibile a due getti, uscita acque separata

# Rubinetteria Professionale

## MISCELATORI 5 VIE



Cod. 6124

Miscelatore 5 vie acque separate canna alta



Cod. 6135

Miscelatore elettronico a 5 vie con doccia estraibile due getti



Cod. 6136

Gruppo doccia 5 vie  
H. tot. cm. 56

# Rubinetteria Professionale

## DISTRIBUTORI ACQUA



Cod. 4515

Rubinetto per fontana  
colonnina acqua a pulsante



Cod. 4516

Rubinetto per fontana  
colonnina acqua a leva con  
attacco M. 1/4"



Cod. 4517

BEVERINO rubinetto a  
pulsante getto parabolico  
per fontanelle



Cod. 6126

Rubinetto a colonna a tre  
leve (senza aeratore)



Cod. 4756

Pistola per SELTZ



Cod. 4757

Pistola per SELTZ a due  
vie

# Rubineria Professionale per LABORATORI

## ***RUBINETTI PER ACQUA con verniciatura epossidica***



Cod. 4289

Rubinetto a 90°  
con portagomma svitabile



Cod. 4290

Rubinetto a parete  
con canna a "S" girevole cm. 25



Cod. 4291

Miscelatore lavello a parete  
con canna a "U" girevole cm. 24



Cod. 4292

Colonna a "L" a 1 rubinetto  
mm. 200



Cod. 4293

Colonna con canna a "S"  
girevole mm 300



Cod. 4294

Miscelatore monoforo  
con canna a ponte mm. 250



Cod. 4988

Miscelatore monopedale in  
tecnopolimero GRIVORY  
per montaggio a parete

# Rubineria Professionale per LABORATORI

***RUBINETTI PER ACQUA con verniciatura epossidica***



Cod. 4298

Gruppo biforo da banco  
con maniglie frontali  
con canna superiore cm. 30



Cod. 4375

Rubinetto incasso

## LAVAOCCHI



Cod. 5065

LAVAOCCHI per bocche erogazioni



Cod. 5034

LAVAOCCHI fisso a parete con  
vaschetta in acciaio inox apertura a  
spinta



# Rubinetteria Professionale IN ACCIAIO INOX



Cod. 3315

Miscelatore lavello con doccia estraibile ORIONE in acciaio inox  
H. Tot. cm. 40



Cod. 3748

Miscelatore VEGA canna alta in acciaio inox  
H. Tot. cm. 37,5



Codice 5059

Corpo doccia in acciaio inox



Cod. 5060

Gruppo doccia con miscelatore leva corta in acciaio inox AISI 304



Codice 0080/inox

Molla di bilanciamento in acciaio inox AISI 304

# Rubinetteria Professionale FOTOCELLULA



**Cod. 3074**

Miscelatore a fotocellula con alimentazione a corrente 220/12V  
H. Tot. cm. 13,5

**Cod. 3074/BT**

Come sopra con alimentazione a batteria al Lithio (4x1,5V)



**Cod. 5001**

Miscelatore SETTEMIX con comando fotocellula, temperatura regolabile.  
Alimentazione a corrente  
H. Tot. cm. 14,5

**Cod. 5001/BT**

Come sopra con alimentazione a batterie alcaline 1,5V (AA)



**Cod. 5025**

Miscelatore Lavello OCEANUS PLUS con comando fotocellula, canna girevole, temperatura regolabile, alimentazione a batteria. DUAL SENSOR - Sensore ON/OFF di flusso continuo  
Con funzionamento di emergenza manuale.



**Cod. 5010**

Miscelatore lavello con comando fotocellula, canna girevole cm 20,5.  
Alimentazione corrente 220V/6V  
H. tot. 37,3

**Cod. 5010/BT**

come sopra  
Alimentazione a batteria Lithio

# Rubinetteria Professionale FOTOCELLULA



Cod. 4475

Miscelatore Lavello DRAGO con comando fotocellula, corpo girevole, temperatura regolabile, con anello girevole per l'erogazione continua dell'acqua (tempo max. 5 min.) Alimentazione a batteria 9 V. H. tot. cm. 39,5



Cod. 5030

Miscelatore Lavello a muro SPEEDYMIX, con comando fotocellula, doppio sensore per erogazione continua. Canna girevole. Alimentazione a batteria (2 pile alcaline 1,5 V.)



Cod. 5061/BT

Miscelatore incasso a muro con comando fotocellula. Alimentazione a batteria (3 pile alcaline 1,5 V.)



Cod. 5044

Miscelatore acqua calda/fredda a muro con fotocellula MINIUNOMIX canna cm. 27 Alimentazione a batteria (2 pile alcaline 1,5 V.)



Cod. 5045

Rubinetto fotocellula a parete MINIUNO con canna cm. 25 Alimentazione a batteria (2 pile alcaline 1,5 V.)



Cod. 5045/C

Rubinetto fotocellula a parete MINIUNO con canna cm. 26. Alimentazione a corrente.

## RICAMBI

Cod. RIC4615

Elettrovalvola per cod. 3074

Cod. RIC0064

Trasformatore per cod. 3074

Cod. RIC3002

Elettrovalvola per cod. 5010 - 5010/BT

Cod. RIC4660BT

Fotocellula per miscelatori fotocellula cod. 3074/BT

Cod. RIC0120

Porta batterie completo per miscelatore cod. 3074/BT

# Rubinetteria Professionale TEMPORIZZATA



Cod. 4441

Miscelatore a pulsante con  
arresto temporizzato



Cod. 0290

Rubinetto temporizzato 1/2



Cod. 0289

Rubinetto temporizzato a  
muro 1/2



Cod. 4461

Rubinetto temporizzato canna  
alta



Cod. 4509

Rubinetto temporizzato con comando  
a leva con aeratore



Cod. 4444

Rubinetto temporizzato per lavamani  
completo di ghiera di fissaggio



Cod. 3528

Rubinetto a ginocchio  
temporizzato ad incasso



Cod. 3537

Miscelatore a ginocchio  
temporizzato ad incasso

# Rubinetteria Professionale RICAMBI - Cartucce



Cod. 0136

**Cartuccia bassa Ø 40 per:**  
codici 0100 - 3025 - 0111 -  
0112 - 0113 - 0120 - 3024 -  
3072- 3060 - 2901 - 2902 -  
3108 - 3819 - 3820 - 3821 -  
3043 - 4297 - 4860 -  
3072/LP - 3211 - 3211/LP -  
3108/LP



Cod. 0171

**Cartuccia alta Ø 40 per:**  
codici 0165 - 0287 - 0284  
- 3503 - 3542 - 0083 -  
3804 - 3806 - 0297



Cod. 0172

**Cartuccia bassa Ø 35  
per:**  
codice 3065



Cod. 0039

**Cartuccia alta Ø 35 per:**  
codici 3220 - 6138 - 6102



Cod. 4518

Cartuccia ceramica Tipo  
Galatron  
(Compatibile con Ø 47)



Cod. 2334

**Cartuccia alta Ø 40 per  
miscelatori GIOVE -  
MARTE - BIFORO -  
TORNADO**  
Codici 3051 - 3052 - 3048  
- 4480 - 3051/TU -  
3052/TU - 4875 - 4870



Cod. 2943

**Cartuccia CX42 per  
miscelatori VECCHIO  
MODELLO (prima del  
2015)** Codici 3051 - 3052 -  
3051/TU - 3052/TU



Cod. 4511

**Cartuccia CX40 per  
miscelatori VECCHIO  
MODELLO (prima del  
2015)** Codici 3048 - 4480

# Rubinetteria Professionale

## RICAMBI



**Cod. 0174**  
Leva cm. 20 chiusa



**Cod. 2949**  
Leva in plastica nera  
cm. 30 per codice  
3051-0026-3055  
**(Nuovo Modello)**



**Cod. RIC0150**  
Leva in plastica nera cm. 23,70  
per codice 3048 - 4480 - 4875 -  
4870 - 3529 - 3530



**Cod. 0124**  
Leva clinica cm.20  
con placchetta



**Cod. 2961**  
Leva corta



Leva in plastica grigia  
**Cod. 0107** - corta  
**Cod. 0108** - cm. 27  
**Cod. 0109** - cm. 32



**Cod. 4494**  
Vitone per rubinetto  
incasso a squadro  
DX/SX cod. 4473 -  
4472



**Cod. RIC4413**  
Vitone ricambio  
(monoforo - 0084 -  
0210)



**Cod. RIC4412**  
Maniglia cromata  
rosso

**Cod. RIC4412B**  
Maniglia cromata blu



**Cod. RIC2929**  
Maniglia atermica  
nera

# Rubinetteria Professionale

## RICAMBI



Canna fusa per cod.  
0026 - 3051 - 3052

Cod. 2934 - cm. 20  
Cod. 2935 - cm. 25



Canna tubo Ø 22 per  
3051/TU - 3059/TU

Cod. 4552 - cm. 20  
Cod. 4553 - cm. 25



Canna tubo Ø 18 per  
3048 - 4480 - 3052/TU  
- 4875 - 4870

Cod. 2919 - cm. 20  
Cod. 2918 - cm. 25



Canna tubo a "U"

Cod. 2932 - cm. 20  
Cod. 2933 - cm. 30



Cod. 4553/40

Canna tubo cm. 40  
Ø 22 per miscelatore  
MARTE - GIOVE/TU

Cod. 2930 - cm. 20  
Cod. RIC4508 - cm. 25  
Cod. 2931 - cm. 30  
Cod. 4554 - cm. 40  
Cod. RIC4508/UN - cm. 25  
universale



Canna tubo a "S"



Canna tubo a "U" parallela  
con attacco universale

Cod. 4717 - cm. 16  
Cod. 2468/UN - cm. 20  
Cod. 2469/UN - cm. 30  
Cod. 4551/UN - cm. 40



Canna tubo a "U" parallela

Cod. 2468 - cm. 20  
Cod. 2469 - cm. 30  
Cod. 4551 - cm. 40



Canna tubo a "S" con  
attacco universale

Cod. RIC4508UN - cm. 25  
Cod. 2931/UN - cm. 30  
Cod. 4554/UN - cm. 40



Canna fusa per cod. 3503  
- 3542

Cod. 2954 - cm. 20  
Cod. 2955 - cm. 30



CANNA YOTA - D.20  
Cod. RIC4529 - cm. 20  
(per cod. 2901 - 4466)

Cod. RIC4530 - cm. 30  
(per cod. 3805-3806-3803-3804-  
2901)



Canna per miscelatore  
KLARCO

Cod. RIC5008 - cm. 20  
Cod. RIC5009 - cm. 25

# Rubinetteria Professionale

## RICAMBI



Cod. RIC0016

Aeratore F. 22x1 (x 3051 - 3048 - 0026 - bocche erogazioni)



Cod. RIC0009

Aeratore M. 24x1 per Miscelatore



Cod. RIC2924

Piantana per bocca erogazione cod. 0089-3028-3102



Cod. 4193

Riduttore di portata ECO



Cod. 1418

Riduttore di portata a taratura fissa Lt. 7



Cod. RIC0170

Doccia dualget in metallo cromata



Cod. RIC4416

Doccia MINIMAL attacco 1/2" ABS doppio getto per miscelatore codice 6138 - 6102



Cod. RIC4626

Doccia metallo doppio getto K2 (ricambio per codice 4965) Attacco 1/2"



Cod. RIC4440

Basetta conica con prolunga



Cod. RIC4642

Flessibile viplato cm. 48 con snodo (per codice 4965)



Cod. RIC2921

Doccia ABS doppio getto attacco 1/2" ricambio per miscelatore 3220 - 3219



Cod. RIC4884

Flessibile inox Ø 14 cm. 53 plastificato x cod. 3220



# Rubinetteria Professionale

## RICAMBI



**Cod. 2956**

Doccia ricambio per miscelatore con doccia estraibile



**Cod. 2957**

Flessibile retinato M. 15x1 cm. 150 per miscelatore con doccia estraibile



**Cod. 2958/RT**

Flessibile retinato M. 15x1 cm. 200 per miscelatore con doccia estraibile



**Cod. 2958**

Flessibile cromato cm. 200 per miscelatore con doccia estraibile



**Cod. 2957/3**

Flessibile retinato M. 15x1 cm. 300 per miscelatore con doccia estraibile

Ricambio per miscelatori codice 3108 - 3108/LP - 0111 - 0112 - 0113



**Cod. RIC0040**

SET Fissaggio per miscelatori



**Cod. RIC4424**

Ricambio plastica nero per cod. 0111 - 0112 - 0113 - 3108 - 3108/LP



**Cod. RIC4657**

KIT completo di fissaggio per miscelatore GIOVE nuovo (codolo - dado - rondella)

**Cod. RIC0040P**

SET Fissaggio con vite cm. 15 per miscelatore cod. 0120 - 0100 - 4729

**Cod. RIC0040/2P**

SET fissaggio per miscelatore 2 viti

**Cod. RIC2962**

SET fissaggio per miscelatore MARTE 3048 - 4480 - 4538 - 4870 - 4872

**Cod. RIC1061**

Codolo di fissaggio mm. 75 per Giove

**Cod. RIC4656**

Controdado per fissaggio miscelatore GIOVE (modello nuovo)

# Rubinetteria Professionale

## RICAMBI



Flessibile per miscelatore

Cod. 2959 - cm. 30 da 3/8"  
Cod. 2959\_1/2 - cm. 30 da 1/2"  
Cod. 0103 - cm. 40 da 3/8" con prol.  
Cod. 3254 - cm. 40 da 1/2"  
Cod. 3254/P - cm. 40 da 1/2" con prol.  
Cod. 4718 - cm. 50 da 3/8"  
Cod. RIC4633/N - KIT 2 Flessibili per Miscelatore GIOVE  
e MARTE (F. 3/8 cm. 40 + F. 3/8 cm. 40 con prol.)



Cod. RIC2947

Kit valvole di non ritorno +  
nipples



Cannetta rigida per miscelatore

Cod. RIC0079 - M. 10x1 cm. 30



Levetta per monoforo  
1/4 di giro

Cod. RIC4410R - A.C.

Cod. RIC4410B - A.F.



Vitone 1/4 di giro per codici:  
0102/SI/LV - 0102LV -  
0105LV - 0116LV -  
0019\_1/2LV - 0019\_3/4LV -  
4569/LV

Cod. RIC4414  
Vitone A.F.

Cod. RIC4414/R  
Vitone A.C.



Cod. RIC0143

Triangolo PVC per  
sostegno miscelatore

# RUBINETTERIA A PEDALE



Cod. 0293

Miscelatore a 2 pedali  
acqua calda e fredda



Cod. 0065

Miscelatore monopedale  
acqua calda e fredda



Cod. 0294

Kit di montaggio per  
miscelatore a pedale acqua  
calda e fredda - attacchi da  
1/2"



Cod. 3518

Miscelatore a 2 pedali  
acqua calda e fredda



Cod. 4467

Miscelatore monopedale  
acqua calda e fredda

Cod. 0294-3/8

Come sopra con attacchi da  
3/8"

Cod. 0296

Kit di montaggio per  
rubinetto a pedale acqua  
fredda



Cod. 2427

Miscelatore a 2 pedali  
acqua calda e fredda



Cod. 2426

Miscelatore monopedale  
acqua calda e fredda



Cod. 2428

Rubinetto a 1 pedale acqua  
fredda



Cod. 3588

Miscelatore a 2 pedali a  
parete acqua calda e fredda



Cod. 3589

Miscelatore monopedale a  
parete acqua calda e fredda



Cod. 3001

Miscelatore a pedale GIRO  
per il montaggio sospeso  
acqua calda e fredda

# RUBINETTERIA A PEDALE

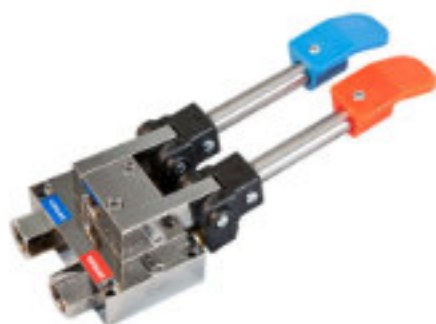

Cod. 3006

Miscelatore a 2 pedali  
acqua calda e fredda



Cod. 5029

Miscelatore monopedale  
acqua calda e fredda  
attacchi posteriori



Cod. 4416

Miscelatore monopedale  
acqua calda e fredda



Cod. 3103

Miscelatore monopedale  
acqua calda e fredda  
montaggio a pavimento ed a  
parete



Cod. 6144

Rubinetto a pedale  
temporizzato da incasso a  
pavimento



Cod. 3523

Miscelatore a pedale/  
ginocchio acqua calda e  
fredda

# RUBINETTERIA A PEDALE con erogazione continua



Cod. 0334

Miscelatore a pedale con  
leva di sblocco montaggio  
sospeso acqua calda e  
fredda



Cod.3104

Staffa acciaio inox  
montaggio sospeso per  
cod. 0334



Cod.3105

Staffa acciaio inox  
montaggio a pavimento per  
cod. 0334

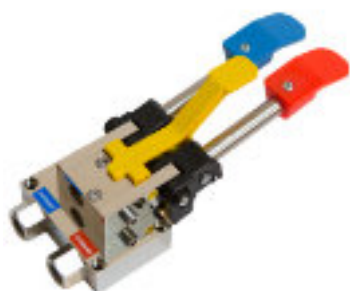

Cod. 4971

Miscelatore a 2 pedali con  
leva di sblocco montaggio a  
pavimento acqua calda e  
fredda



Cod. 3547

Miscelatore a pedale con  
leva di sblocco montaggio a  
pavimento acqua calda e  
fredda



Cod. 3813

Miscelatore a pedale con  
leva di sblocco montaggio a  
pavimento acqua calda e  
fredda



Cod. 4456

Miscelatore pedale GIRO con leva di  
sblocco acqua calda fredda  
montaggio sospeso

# RUBINETTERIA A PEDALE per Supermercati



Cod. 4418

Miscelatore a farfalla sottomobile acqua calda e fredda

Cod. 4418/MT

NEW



Miscelatore a farfalla sotto mobile acqua calda e fredda con **CARTUCCIA METALLO**



Cod. 3510

Staffa h. cm. 7 per miscelatore pedale farfalla cod. 4418 montaggio sospeso

Cod. 3041

Come sopra h. cm. 10



Cod. 3535

Staffa h. cm. 11 per miscelatore pedale farfalla cod. 4418 montaggio a pavimento



Cod. 3113

Staffa piana acciaio inox cm. 47x13,5x sp. 1,5



Cod. 5035

Miscelatore a pedale inox montaggio sospeso



Cod. 5036

Miscelatore pedale INOX con leva di sblocco montaggio sospeso



Cod. 4770

NEW

Miscelatore a pedale a due leve 1/4 di giro acqua calda e fredda montaggio sospeso



Cod. 4771

NEW

Staffa acciaio inox per montaggio sospeso cod. 4770

# RICAMBI per RUBINETTERIA A PEDALE



Cod. 0136

Cartuccia bassa Ø 40 per  
miscelatore codice 4418



Cod. 0161

Cartuccia Ø 40 bassa  
perno in metallo per  
miscelatore codice  
4418/MT



Cod. 3523

Miscelatore ricambio per codice  
5035 e codice 5036



Levetta ¼ di giro per  
miscelatore codice  
4770

Cod. RIC4410R - A.C.

Cod. RIC4410B - A.F.



Vitone ¼ di giro per  
miscelatore codice 4770

Cod. RIC4414  
Vitone A.F.

Cod. RIC4414/R  
Vitone A.C.

Per i ricambi dei miscelatori a pedale consigliamo di chiedere l'esploso dettagliato

# RUBINETTERIA A GINOCCHIO



Cod. 0087

Rubinetto a ginocchio



Cod. 0088

Gruppo miscelazione per rubinetto a ginocchio



Cod. 3528

Rubinetto a ginocchio temporizzato ad incasso



Cod. 3537

Miscelatore a ginocchio temporizzato ad incasso



Cod. 3106

Rubinetto a ginocchio per comando a ginocchiera



Cod. 4444

Rubinetto a ginocchio temporizzato ad incasso



Cod. RIC4442

Placca in acciaio inox per codice 4444



Cod. 3027

Premiscelatore



# BOCCHE EROGAZIONE



Bocca erogazione girevole

- Cod. 3102 - h. cm. 15 x L. cm. 21
- Cod. 3587 - h. cm. 18 x L. cm. 23
- Cod. 0089 - h. cm. 21 x L. cm. 29
- Cod. 3128 - h. cm. 19 x L. cm. 30
- Cod. 3100 - h. cm. 22 x L. cm. 35
- Cod. 3812 - h. cm. 24 x L. cm. 40



Bocca erogazione girevole

- Cod. 3127 - h. cm. 27 x L. cm. 26
- Cod. 3129 - h. cm. 30 x L. cm. 31
- Cod. 3101 - h. cm. 38 x L. cm. 35



Bocca erogazione girevole

- Cod. 3028 - h. cm. 16 x L. cm. 20



Cod. 0063

Bocca erogazione girevole  
h. cm. 17 x L. cm. 15,5



Cod. 0064

Bocca erogazione fissa  
h. cm. 8 x L. cm. 12



Rondella stringiforo per bocche erogazioni

Cod. 2920 - acciaio inox Ø est. 51 x Ø int. 22 mm.

Cod. 2921 - ottone cromato Ø est. 60 x Ø int. 28 mm.



Bocca erogazione girevole parallela superiore

Cod. 3133/20 - cm. 20

Cod. 3133 - cm. 30

Cod. 4434 - cm. 40

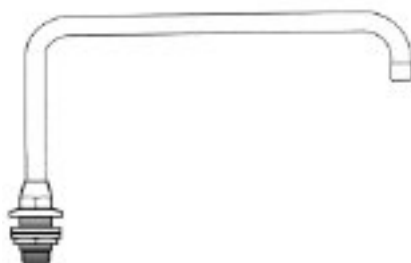

Cod. 4492

Bocca erogazione girevole a squadro h. cm. 25 x L. cm. 46



Bocca erogazione girevole fusa pesante

Cod. 2990 - h. cm. 19 x L. cm. 20

Cod. 2991 - h. cm. 23 x L. cm. 25

# BOCCE EROGAZIONE



Bocca erogazione girevole a parete parallela

Cod. 4259 - cm. 20  
Cod. 4408 - cm. 25  
Cod. 4474 - cm. 30  
Cod. 4474/40 - cm. 40



Cod. 4463  
Bocca erogazione fissa a parete cm. 16,2



Cod. 4439  
Erogatore con doccia estraibile per attacco miscelatore a pedale



Cod. 3584  
Bocca a muro doppio snodo a muro cm. 50



Cod. 2598  
Adattatore per doppio snodo

# DOCCE da Forno e da Banco



**Cod. 3020**  
Doccia eco + flessibile  
cm. 200

**Cod. 2947**  
solo doccia

**Cod. 2948**  
solo flessibile



**Cod. 3050**  
Doccia da forno professionale  
con flessibile mt. 2 + supporto

**Cod. 3050/150**  
come sopra con flessibile mt. 1,5

**Cod. 3050/3**  
come sopra con flessibile mt. 3

**Cod. 3054**  
solo doccia

**Cod. 0074**  
solo flessibile mt. 2



**Cod. 3045**  
Doccia da forno STAR pesante,  
completa di flessibile da mt. 2 e  
supporto

**Cod. 3045/3**  
come sopra con flessibile mt. 3

**Cod. 3046**  
solo doccia

**Cod. 0074**  
solo flessibile mt. 2



**Cod. 3053**  
Supporto per doccia  
cod. 3050 - 3045

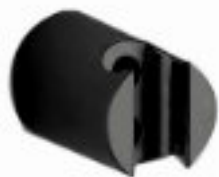

**Cod. 2917**  
Supporto ABS per doccia  
cod. 3020 (opzionale)

# DOCCE da Forno e da Banco



**Cod. 4409**

Doccia per forno con avvolgitubo flessibile cm. 170  
dimensioni: cm. 11,5x20,2

**Cod. RIC4899**

doccia di ricambio

**Cod. RIC4599**

Flessibile cm. 170 per cod. 4409



**Cod. 4964**

Doccia da forno a pulsante, completa di flessibile da mt. 2 e supporto

**Cod. 4964/SD**

solo doccia



**Cod. 0125**

Doccia estraibile da banco completa di flessibile cm. 200 e borchia fissaggio al piano

**Cod. 2942**

solo borchia di fissaggio

**Cod. 0074**

solo flessibile cm. 200



**Cod. 4272**

Anticalcare magnetico per forni M.F. 3/4"

# SIFONI E PILETTE



**Cod. 1088**  
Sifone 1 Via P.P. Grigio 1"1/2  
tubo scarico Ø 40



**Cod. 1089**  
Sifone 2 Vie P.P. Grigio 1"1/2  
tubo scarico Ø 40

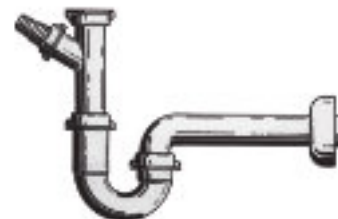

**Cod. 1608**  
Sifone 1 Via P.P. Grigio  
con attacco lav. 1"1/2  
tubo scarico Ø 40



**Cod. 1606**  
Sifone moplen 1 via x inox  
1"1/2 canotto Ø 40 bianco



**Cod. 1607**  
Sifone moplen 2 vie x  
inox 1"1/2 canotto Ø 40  
bianco



**Cod. 1609**  
Sifone 2 Vie P.P. grigio  
con attacco lav. 1"1/2  
tubo scarico Ø 40



**Cod. 4520**  
Sifone 1 Via P.P.  
grigio 1"1/2 tubo  
scarico Ø 40 LIRA



**Cod. 4521**  
Sifone 2 Vie P.P.  
grigio 1"1/2 tubo  
scarico Ø 40 LIRA



Sifone ottone 1 via

**Cod. 0091** - 1"1/2  
**Cod. 0092** - 2"



**Cod. 4990**  
Sifone salvaspazio 1 Via  
da 2"



**Cod. 4991**  
Sifone salvaspazio 2 Vie  
da 2"



**Cod. 4695**  
Sifone 1 Via P.P.  
salvaspazio grigio 1"1/2  
+ att. lav. per inox tubo  
scarico Ø 40

**Cod. 4696**  
Sifone 2 Vie P.P.  
salvaspazio grigio 1"1/2  
+ att. lav. per inox tubo  
scarico Ø 40

# SIFONI E PILETTE



Cod. 4584

Piletta P.P. 1"1/2

Cod. 3536

Piletta P.P. 1"1/2 per troppo pieno Ø 50



Piletta ottone cromato

Cod. 0093 - 1"1/2

Cod. 0094 - 2"

Guarnizione gomma di ricambio per piletta ottone

Cod. RIC4902 - 1"1/2

Cod. RIC4903 - 2"



Troppo pieno in acciaio inox

Cod. 0333 - Ø 40 per piletta 1"1/2 cm. 30

Cod. 3548 - Ø 50 per piletta 2" cm. 30

**SU ORDINAZIONE**  
possibilità di avere  
lunghezze personalizzate



Cod. 4154

Piletta lavabo S.T.P 1"  
H. 85 mm.



Piletta ottone cromato 3/4"

Cod. 4809 - codolo mm. 50

Cod. 4809/30 - codolo mm. 30

Cod. 4809/17 - codolo mm. 17



Cod. 2422

Troppo pieno per piletta da 3/4 mm. 54

Cod. 3938

Troppo pieno per piletta da 3/4 mm. 170



Cod. 5040/30

Troppo pieno con filtro  
cm. 30 per piletta da  
1"1/2

Cod. 5062

Troppo pieno con filtro  
cm. 30 per piletta da 2"



Cod. 3534

Piletta ottone cromato  
1/2" con flangia  
inclinata



Cod. 4891

Piletta di scarico 1/2"  
flangia dritta

# SIFONI E PILETTE



Piletta per lavelli industriali

Cod. 1628 - 2"  
Cod. 4579 - 1"1/2



Piletta PVC

Cod. 4931 - 1/2"  
Cod. 4932 - 1" H. 90  
Cod. 4933 - 1"1/2 H. 85



Ghiera PVC

Cod. 4940 - 1/2"  
Cod. 4941 - 1"  
Cod. 4942 - 1"1/2  
Cod. 4943 - 2"



Cod. 1563  
Vidò per lavello acciaio inox



Cod. 4935  
Piletta PVC 2"  
senza ghiera



Cod. 4936  
Cappello PVC  
per piletta 2"



Cod. 3848  
Riduzione P.P.  
1"1/2 M. x 2" F.

Cod. 1049  
Riduzione P.P.  
M. 1"1/4 x F. 1"1/2

Cod. 1636  
Riduzione P.P.  
M. 1"1/2 x F. 1"1/4



Tubo flessibile spiralato

Cod. 4646 - Ø 32  
Cod. 4647 - Ø 40



Tubo Idroflex

Cod. 4653 - 1" x Ø 26-32  
Cod. 4654 - 1"1/4 x Ø 32  
Cod. 4655 - 1"1/2 x Ø 40



Manicotto per tubo flessibile spiralato

Cod. 4648 - Ø 26 x tubo Ø 32

Cod. 1114 - Ø 32 x tubo Ø 32

Cod. 4649 - Ø 32 x tubo Ø 40

Cod. 4650 - Ø 40 x tubo Ø 32

Cod. 1115 - Ø 40 x tubo Ø 40



Raccordo per tubo flessibile spiralato

Cod. 4651 - con girello da 1"1/4

Cod. 4652 - con girello da 1"1/2

# AVVOLGITUBI E PISTOLE



Cod. 3828

Avvolgitubo professionale a muro in acciaio inox con ritorno a molla Ø 44 cm.



Tubo in poliuretano anti olio con retinatura non dilatabile fino alla pressione di esercizio 20 bar.

Temp. -15° +65° C.

Per avvolgitubo cod. 3828

Cod. 3829 - mt. 10

Cod. 3830 - mt. 15

Cod. 4834

Tubo in gomma blu liscio 1/2" Ø int. 12 mm. Ø est. 20 mm. max 15 bar 110°C



Cod. 3577

Staffa girevole acciaio inox per cod. 3828 e cod. 3856



Cod. 3575

Avvolgitubo carenato inox completo di 10 mt. di tubo poliuretano press. max 20 bar. Dimensioni: cm. L. 30xp.15xh.30



Cod. 4580

Staffa girevole acciaio inox per cod. 3575



Cod. 3856

Avvolgitubo professionale a muro in acciaio inox **completo di tubo in gomma blu 1/2" mt. 10**



# AVVOLGITUBI E PISTOLE



**Cod. 3576**

Avvolgitubo carenato in plastica completo di 15 mt. di tubo poliuretano e staffa girevole press. max 20 bar.  
Dimensioni: cm. L.30xp.15xh.30



**Cod. 3582**

Pistola getto regolabile bassa pressione max 10 bar temp. max 50°C.



**Cod. 3583**

Pistola professionale getto regolabile bassa pressione max 24 bar temp. max 94°C.



**Cod. 4402**

Pistola polipropilene getto fisso max 25 bar temp. max. 60°C.



**Cod. 4419**

Innesto rapido 1/2" M. x 1/2" M. in ottone cromato max 10 bar 80° C.

## RICAMBI

**Cod. RIC1013** - Tubo ricambio per avvolgitubo cod. 3575 mt. 10

**Cod. RIC1012** - Tubo ricambio per avvolgitubo cod. 3576 mt. 15

**Cod. RIC4605** - Riduzione 3/4" x 1/4" (pos. 19) per avvolgitubo cod. 3575 - 3576 (pos. 14a)

**Cod. RIC4534** - Giunto girevole da 1/4" (pos. 14 per cod. 3576) (pos. 20 per cod. 3575)

**Cod. RIC4637** - Raccordo molla per tubo

**Cod. 3342** - Riduzione 1/2" x 1/4" ottone cromato

**Cod. RIC4579** - Giunto inox 1/2" completo per avvolgitubo cod. 3828 (pos. 33)

**Cod. RIC4509** - Palla ferma tubo 1/4" per avvolgitubo

**Cod. RIC4624** - Nipples girevole 1/2" in ottone per pistola cod. 3582

# RUBINETTI DI SCARICO



**Cod. 3012**

Rubinetto di scarico con sicurezza attacco girevole da 2" F.

**Cod. 3012/OR**

Come sopra con tenuta OR



**Cod. 3014**

Rubinetto di scarico attacco M. 78x3



Rubinetto di scarico fisso femmina

**Cod.3554** - 1"

**Cod.3553** - 1"1/4

**Cod.3573** - 1"1/2



**Cod. 3574**

Rubinetto di scarico attacco girevole 1"1/2 F. con sicurezza



**Cod. 3013**

Rubinetto di scarico attacco M. 3/4"



**Cod. 3552**

Rubinetto di scarico fisso F. 2"

# RUBINETTI DI SCARICO



Cod. 5053

Rubinetto di scarico da 2"  
GBM conico con borchia  
inox per pentolone  
ANGELO PO



Cod. 4253

Rubinetto di scarico per  
friggitrice attacco fisso F.  
3/4"



Rubinetto di scarico DELUX  
in acciaio inox AISI 316

Cod. 4967 - F. 1"1/2

Cod. 4968 - M. 1"1/2

Cod. 4969 - F. 2"

Cod. 4970 - M. 2"

## RICAMBI

Cod. RIC1041

OR per rubinetto di scarico da  
2" GB6212 Ø 53,34x5,33

Cod. 4157

Tubetto grasso FOOD per  
rubinetti di scarico sede conica

Cod. RIC4592

Impugnatura per rubinetto di  
scarico da 2"

Cod. 4158

Tubetto grasso FOOD per  
rubinetti di scarico con OR

Cod. RIC4594

Impugnatura per rubinetto di  
scarico da 1"1/4 e 1"1/2

Cod. RIC4622

Guarnizione per rubinetto di  
scarico da 2" Ø 60x49,9x2

# GRUPPI DI SICUREZZA PER VAPORE



Gruppo di sicurezza verticale per vapore completo

Cod. 3016 - 3/4"

Cod. 3015 - 1"1/4



Cod. 4858

Gruppo di sicurezza a squadra per vapore completo da 1"1/4



Valvola di sicurezza a molla

Cod. 3017 - 3/4"

Cod. 3018 - 1"1/4



Cod. 4707

Valvola di depressione da 3/4"



Cod. 3019

Manometro M. 1/4"



Cod. 3340

Rubinetto porta manometro 1/4"



Cod. 3341

Sifone porta manometro M. 1/2"



Cod. 4996

Valvola per vapore a squadra F. 1"1/4



Cod. 5005

Valvola per vapore diritta 3/4"



Cod. 2899

Valvola per vapore a squadra M. 1"

# TUBI CARICO PER ALTA TEMPERATURA



Temperatura max 100° - Ø int. 13 mm.

Tubo carico lavastoviglie in treccia inox 3/4" F. x 3/4" F. CURVO

Cod. 3131	cm. 25
Cod. 3130	cm. 50
Cod. 3114	cm. 100
Cod. 3115	cm. 150
Cod. 3116	cm. 200
Cod. 3117	cm. 300



Temperatura max 100° - Ø int. 13 mm.

Tubo carico Lavastoviglie in treccia inox 3/4" F. x 3/4" F. DIRITTO

Cod. 4704	cm. 100
Cod. 4705	cm. 150
Cod. 4706	cm. 200
Cod. 4708	cm. 300



Temperatura max 90° - Ø int. 10 mm.

Tubo carico in gomma nera curvo 3/4" F. x 3/4" F.

Cod. 2339	cm. 150
Cod. 2340	cm. 200



Temperatura max 90°

Tubo carico lav. in gomma grigia professionale F.F. 3/4" curvo **con dado e curva in metallo**

Cod. 2952	cm. 200
-----------	---------



Tubo carico inox Ø 30 F.F. 3/4" con curva

Cod. 4541	cm. 50
Cod. 4542	cm. 75
Cod. 4543	cm. 100

# TUBI CARICO PER ALTA TEMPERATURA



Temperatura max 90° - Ø int. 13 mm.

Tubo carico lavastoviglie in gomma professionale 10 bar 3/4" F. x 3/4" F. CURVO

Cod. 2582	cm. 100
-----------	---------

Cod. 2580	cm. 150
-----------	---------

Cod. 2581	cm. 200
-----------	---------

Cod. 4723	cm. 300
-----------	---------



Temperatura max 90° - Ø int. 13 mm.

Tubo carico lavastoviglie in gomma professionale 10 bar 3/4" F. x 3/4" F. DIRITTO

Cod. 2580/D	cm. 150
-------------	---------

Cod. 2581/D	cm. 200
-------------	---------



Temperatura max 90° - Ø int. 13 mm.

Tubo carico lavastoviglie in gomma professionale 10 bar 3/4" F. X 3/4" F. curvo **con dadi in metallo**

Cod. 2580/DM	cm. 150
--------------	---------

Cod. 2581/DM	cm. 200
--------------	---------

Cod. 4723/DM	cm. 300
--------------	---------



Temperatura max 100° - Ø int. 13 mm.

Tubo carico lavastoviglie in nylon 3/4" F. x 3/4" F. curvo

Cod. 4734	cm. 100
-----------	---------

Cod. 4735	cm. 150
-----------	---------

Cod. 4736	cm. 200
-----------	---------

Cod. 4737	cm. 300
-----------	---------

# TUBI CARICO PER BASSA TEMPERATURA



Temperatura max 25° - Ø int. 10 mm.

Tubo carico lavastoviglie in gomma grigia  
3/4" F. x 3/4" F. CURVO

Cod. 2569 - cm. 100  
Cod. 2570 - cm. 150  
Cod. 2571 - cm. 200  
Cod. 2573 - cm. 300



Temperatura max 25° - Ø int.10 mm.

Tubo carico lavastoviglie in gomma grigia  
3/4" F. x 3/4" F. DIRITTO

Cod. 4699 - cm. 100  
Cod. 4700 - cm. 150  
Cod. 4701 - cm. 200  
Cod. 4702 - cm. 250  
Cod. 4703 - cm. 300



Tubo carico per alimenti retinato

Cod. 4852 - cm. 150  
Cod. 4853 - cm. 200  
Cod. 4854 - cm. 250

# TUBI CARICO

## Accessori e Ricambi



**Cod. 0826**  
Tubo treccia inox 13x18 zincato al metro

Raccordi per tubo al metro codice 3826

**Cod. 0825** - Fascetta stringi tubo

**Cod. 0827** - Curva 1/2" G. 13 in ottone sede piana

**Cod. 0827\_3/4** - Curva 3/4" G. 13 in ottone sede piana

**Cod. 0828** - Cartella 1/2" ottone G. 13 sede piana

**Cod. 0828\_3/4** - Cartella 3/4" ottone G. 13 sede piana

**Cod. 0830** - Dado 1/2" ottone CH24 foro 14,5

**Cod. 0830\_3/4** - Dado 3/4" ottone CH24 foro 14,5

**Cod. 0831** - Dado 1/2" ottone CH24 foro 16

**Cod. 0831\_3/4** - Dado 3/4" ottone CH24 foro 16



**Cod. 4697**  
Guarnizioni per tubo carico



**Cod. 3422**  
TE ottone giallo M. 3/4" x M. 3/4" x M. 3/4"



**Cod. 4499**  
Guarnizioni con filtro per tubi carico



**Cod. 3629**  
NIPPLES 3/4" PVC



**Cod. 2495**  
Raccordo a Y in plastica 3/4" M. x 3/4" M. x 3/4" F.



**Cod. 2806/MT**  
Raccordo a Y in ottone cromato 3/4Mx3/4Mx3/4F



**Cod. 4272**  
Anticalcare magnetico M.F. 3/4" per fabbricatore di ghiaccio



# TUBI SCARICO LAVASTOVIGLIE



Tubo scarico spiralato per lavabicchieri

Cod. 2576	cm. 150
Cod. 2577	cm. 200
Cod. 2578	cm. 300



Tubo scarico spiralato estensibile

Cod. 2575	fino a cm. 300
-----------	----------------



Tubo scarico per lavastoviglie  
Ø int. 28 - 23 mm.

Cod. 3591	cm. 200
-----------	---------



Tubo scarico per lavastoviglie industriali

Cod. 2597	cm. 200
-----------	---------

# TUBI SCARICO LAVASTOVIGLIE

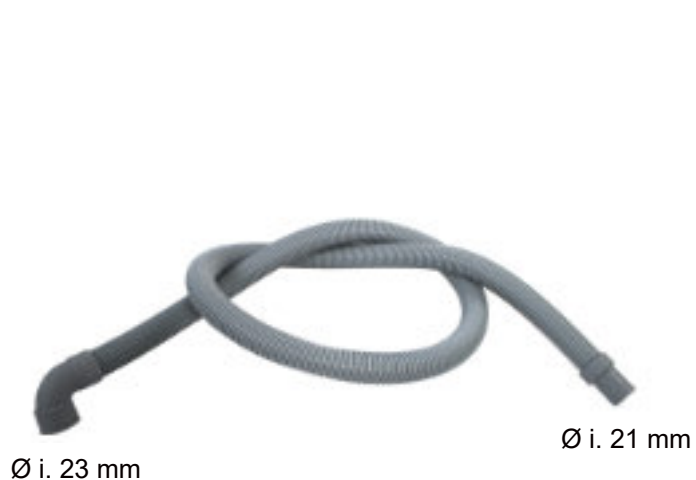

Tubo scarico con pipa  
Ø int. 23 - Ø int. 21 mm

Cod. 3593 cm. 200



Tubo scarico industriale con pipa  
Ø int. 40 mm - Ø int. 32 mm

Cod. 3594 cm. 200



Tubo scarico con pipa  
Ø int. 28 - Ø int. 23 mm

Cod. 4400 cm. 200

# FLESSIBILI PER ACQUA



## Flessibile Ø normale M.F. 1/2"

cod. 1226	- cm. 20
cod. 1227	- cm. 25
cod. 1228	- cm. 30
cod. 1229	- cm. 35
cod. 3565	- cm. 40
cod. 3566	- cm. 50
cod. 4742	- cm. 60
cod. 3567	- cm. 70
cod. 4482	- cm. 80
cod. 3568	- cm. 100
cod. 2994	- cm. 120
cod. 3569	- cm. 150
cod. 3570	- cm. 200
cod. 4752	- cm. 300

## Flessibile Ø normale F. 1/2" X F. 3/8"

cod. 1252	- cm. 20
cod. 1253	- cm. 25
cod. 1254	- cm. 30
cod. 1255	- cm. 40
cod. FL0012	- cm. 50
cod. FL0046	- cm. 80
cod. FL0024	- cm. 150
cod. FL0023	- cm. 200

## Flessibile Ø normale F.F. 1/2"

cod. 1244	- cm. 20
cod. 1245	- cm. 25
cod. 1246	- cm. 30
cod. 1247	- cm. 40
cod. FL0010	- cm. 50
cod. FL0047	- cm. 60
cod. 1140	- cm. 70
cod. FL0048	- cm. 80
cod. 1141	- cm. 100
cod. FL0013	- cm. 120
cod. 4926	- cm. 130
cod. 1142	- cm. 150
cod. 1143	- cm. 200
cod. 1144	- cm. 250

## Flessibile Ø normale M.F. 3/8"

cod. 1232	- cm. 20
cod. 1233	- cm. 25
cod. 1234	- cm. 30
cod. 1235	- cm. 40
cod. FL0007	- cm. 50
cod. FL0014	- cm. 70
cod. FL0045	- cm. 80
cod. FL0015	- cm. 100
cod. FL0042	- cm. 120
cod. FL0021	- cm. 200

## Flessibile Ø normale M. 3/8" x F. 1/2"

cod. 1236	- cm. 20
cod. 1237	- cm. 25
cod. 1238	- cm. 30
cod. 1239	- cm. 40
cod. FL0008	- cm. 50
cod. FL0037	- cm. 60
cod. FL0018	- cm. 70
cod. FL0038	- cm. 80
cod. FL0019	- cm. 100
cod. FL0017	- cm. 120
cod. FL0020	- cm. 150

## Flessibile Ø normale F.F. 3/8"

cod. 1248	- cm. 20
cod. 1249	- cm. 25
cod. 1250	- cm. 30
cod. 1251	- cm. 40
cod. FL0011	- cm. 50
cod. FL0039	- cm. 60
cod. FL0040	- cm. 80
cod. FL0033	- cm. 100
cod. FL0022	- cm. 200

## Flessibile Ø normale M. 1/2" X F. 3/8"

cod. 1240	- cm. 20
cod. 1241	- cm. 25
cod. 1242	- cm. 30
cod. 1243	- cm. 40
cod. FL0009	- cm. 50
cod. FL0016	- cm. 70

# FLESSIBILI PER ACQUA



## Flessibile Ø gigante M.F. 1/2"

cod. 4709	cm. 30
cod. 3134	cm. 40
cod. 3135	cm. 50
cod. 3136	cm. 60
cod. 3137	cm. 100



## Tubo acciaio inox M.F. 1" senza guaina estensibile

cod. 1853	da cm. 26 a cm. 52
cod. 1852	da cm. 50 a cm. 100
cod. 1843	da cm. 100 a cm. 200



## Tubo per autoclave acqua calda e fredda

cod. 3090 - M.F. 3/4"	cm. 50
cod. 3091 - M.F. 3/4"	cm. 70
cod. 4711 - M.F. 1"	cm. 50
cod. 3089 - M.F. 1"	cm. 60
cod. 1406 - M.F. 1"	cm. 70



## Flessibile con prolunga M. 1/2" per bicono Ø 10

cod. 3138	cm. 40
cod. 4713	cm. 70



## Flessibile bianco per acqua M.F. 3/8"

cod. 4295	cm. 50
cod. 4505	cm. 120
cod. 4535	cm. 150
cod. 4530	cm. 200
cod. 4490	cm. 300



## Flessibile in treccia inox 1/2" F. x 1/2" F. girevole

cod. 4410	mt. 2
-----------	-------

# FLESSIBILI PER ACQUA



## Guarnizioni per flessibili

cod. 4831	3/8"
cod. 4572	1/2"
cod. 4573	3/4"
cod. 4578	1"



cod. 4898

Tubo UNIROLL acciaio inox per acqua 1/2" rotoli da 30 mt.

# TUBI PER ALLACCIAMENTO GAS



## TUBI GAS INOX a norma UNI EN 14800 M.F.

Cod. 3757	M.F. 1/2" mt. 0,50
Cod. 3758	M.F. 1/2" mt. 0,75
Cod. 4522	M.F. 1/2" mt. 1
Cod. 4523	M.F. 1/2" mt. 1,5
Cod. 4524	M.F. 1/2" mt. 2



## TUBI GAS INOX a norma UNI EN 14800 F.F.

Cod. 3759	F.F. 1/2" mt. 0,50
Cod. 4525	F.F. 1/2" mt. 1
Cod. 4526	F.F. 1/2" mt. 1,5
Cod. 4527	F.F. 1/2" mt. 2



## TUBI GAS INOX a norma UNI-CIG 9891

Cod. 3030	F.F. 3/4" Estensibile fino a mt. 1
Cod. 3031	F.F. 3/4" Estensibile fino a mt. 2

Cod. 3032	M.F. 3/4" Estensibile fino a mt. 1
Cod. 3033	M.F. 3/4" Estensibile fino a mt. 2

Cod. 3034	M.F. 1" Estensibile fino a mt. 1
Cod. 3035	M.F. 1" Estensibile fino a mt. 2

Cod. 3036	M.F. 1/2" Estensibile da 22 a 42 cm.
Cod. 3037	M.F. 3/4" Estensibile da 22 a 42 cm.
Cod. 3038	M.F. 1" Estensibile da 22 a 42 cm.



## TUBI GAS INOX LONG F.F. a norma UNI EN 15266:2007 F.F.

Cod. 4777	F.F. 1/2" mt. 3
Cod. 4778	F.F. 1/2" mt. 4



## Guarnizioni alluminio per tubi gas

Cod. 4581	1/2"
Cod. 4585	3/4"
Cod. 4586	1"

# TUBI PER ALLACCIAMENTO GAS



Tubo UNIROLL acciaio inox rivestito per Gas 1/2" - normativa EN 15266

Cod. 3772 - Rotoli da 30 mt.

Cod. 3772/20 - Rotoli da 20 mt.



Cod. 3774

Nastro adesivo per tubo UNIROLL



Cod. 3773

KIT di montaggio per tubo gas UNIROLL dado + anello + ranella



Cod. 3775

Nipples 1/2" ottone cromato sede piana

# FLESSIBILI CONICI per macchine caffè



## Flessibili inox conico

cod. 4451 - F.F. 3/8" cm. 40

cod. 4452 - F.F. 3/8" cm. 60

cod. 4453 - F.F. 3/8" cm. 100

cod. 4454 - F.F. 3/8" cm. 150

cod. 4455 - F.F. 3/8" cm. 200



## Flessibili inox conico con curva

cod. 4800 - F.F. 3/8" cm. 60

cod. 4469 - F.F. 3/8" cm. 100

cod. 4470 - F.F. 3/8" cm. 150

cod. 4471 - F.F. 3/8" cm. 200



# PATTUMIERE ACCIAIO INOX



**PATTUMIERA in acciaio inox CON PEDALE**

Cod. 3595	- Lt. 50 - mm 380x605
Cod. 4414	- Lt. 75 - mm 450x605
Cod. 3596	- Lt. 90 - mm 450x685



**PATTUMIERA in acciaio inox**

Cod. 3597	- Lt. 50 - mm 380x605
Cod. 4407	- Lt. 90 - mm 450x685

## RICAMBI



**Cod. 3079**

Ruota per pattumiera



**Cod. RIC4658**

Pedale per pattumiera

# TRAMOGGIA ACCIAIO INOX



Cod. 4404

TRAMOGGIA in acciaio inox

LT. 115 - cm. 39 x 61 x h. 72

Cod. 4405

TRAMOGGIA in acciaio inox **con divisorio** interno a metà

LT. 115 - cm. 39 x 61 x h. 72

## RICAMBI



Codice 2998

Ruota per tramoggia

# CARRELLI ACCIAIO INOX



Cod. 3598

CARRELLO acciaio inox 2 piani cm. **100x50**

Cod. 4491

CARRELLO acciaio inox 2 piani cm. **80x50**

**Tutti i carrelli sono  
dotati di  
RUOTE FRENANTI**

Cod. 3599

CARRELLO acciaio inox 3 piani cm. **100x50**

Cod. 4539

CARRELLO acciaio inox 3 piani cm. **80x50**



## RICAMBI

Codice RIC1019 - Ruota per carrello

Codice RIC1019CF - Ruota per carrello con freno

Codice 4528 - Pannello silenziatore

# LAVAMANI ACCIAIO INOX



**Cod. 3516**

Lavamani con schienale in acciaio inox completo di miscelatore temporizzato con comando a ginocchio e bocca erogazione girevole.

**Cm. 48 x 35 x h. 52**



**Cod. 3519**

Lavamani in acciaio inox completo di miscelatore temporizzato con comando a ginocchio e bocca erogazione girevole.

**Cm. 50 x 40 x h. 33,5**



**Cod. 4501**

Lavamani in acciaio inox completo di miscelatore temporizzato con comando a ginocchio e bocca erogazione girevole.

**Cm. 30 x 31,5 x h. 17**

**Cod. 4980**

Come sopra **cm. 40 x 40 h. 17**



**Cod. 4447**

Lavamani in acciaio inox completo di miscelatore temporizzato con comando a ginocchio e bocca erogazione girevole.

**Cm. 40 x 40 x h. 33,5**



**Cod. 3590**

Colonna in acciaio inox per codice 3519 - 4447 - 4549

# LAVAMANI ACCIAIO INOX



Cod. 3579

Lavamani su mobile in acciaio inox con sportello, completo di miscelatore temporizzato con comando a ginocchio e bocca erogazione girevole.

**Cm. 50 x 40 x h. 85**

Cod. 3579/50

Come sopra **cm.50 x 50 x h. 85**



Cod. 4546

Lavamani su mobile in acciaio inox con sportello, completo di miscelatore temporizzato con comando a ginocchio e bocca erogazione girevole.

**Cm. 40 x 40 x h. 85**



Cod. 4406

Lavamani su mobile in acciaio inox con sportello, completo di **miscelatore a pedale** e bocca erogazione girevole.

**Cm. 50 x 40 x h. 85**

# LAVAMANI ACCIAIO INOX



Cod. 3515

Lavamani a muro in acciaio inox  
completo di miscelatore a pedale e  
bocca erogazione girevole.  
**Cm. 50 x 40 x h. 80**

# LAVAMANI ACCIAIO INOX



Cod.3522

Lavamani a parete in acciaio inox  
**senza rubinetteria.**  
Cm. 38 x 29



Cod.4549

Lavamani in acciaio inox **senza  
rubinetteria.**  
Cm. 50 x 40 x h. 33,50



Cod.3508

Lavamani a parete in acciaio inox  
**senza rubinetteria.**  
Cm. 40 x 32 x h. 19



Cod.3514

Kit accessori per lavamani codice  
3508 - 3522.  
Composto da: bocca erogazione,  
rubinetto a ginocchio, gruppo  
miscelazione, flessibile inox

# RICAMBI PER LAVAMANI



Cod. RIC4442

Placca in acciaio inox  
con vite  
(ricambio per lavamani  
temporizzati)



Cod. RIC4444

Rubinetto temporizzato  
(ricambio per lavamani  
temporizzati)



Cod. 3027

Pre miscelatore  
(ricambio per lavamani  
temporizzati)



Cod. RIC4450

Bocca erogazione per  
lavamani cm. 13,5 x h. 14



Cod. 4584

Piletta P.P. 1"1/2



Cod. RIC4448

Pedale per lavamani codice  
4406



Cod. 3523

Miscelatore a pedale/ginocchio  
Ricambio per lavamani codice  
3515 - 4406

Cod. RIC4448/33

Pedale per lavamani codice  
3515



# ACCESSORI PER LAVAMANI



Codice 2972/BT

Dosatore di sapone e gel igienizzante **PROFESSIONALE con comando a fotocellula** in ABS bianco alimentazione a batteria Capacità: Lt. 1



Codice 2953

Dosatore di sapone e gel igienizzante **con comando a fotocellula** Basic in ABS alimentazione a batteria Capacità: Lt. 1



Codice 2424

Dosatore di sapone inox con apertura a gomito Capacità: Lt. 1,2



Codice 4951

Dosatore di sapone inox elettronico alimentazione a batteria Capacità: Lt. 1



Codice 4917

Distributore di sapone ad incasso Capacità: Lt. 1,1



Codice 4286

Sterilizzatore di coltelli in acciaio inox da banco

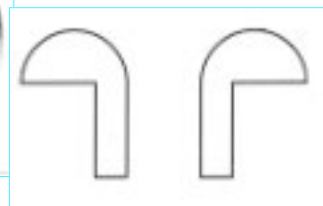

Codice 4930

Collare per foro sbarazzi gomma nera foro del piano Ø mm. 205

# ACCESSORI PER LAVAMANI



**Codice 4714**  
Dispenser salviette  
carta asciugamani inox



**Codice 3521**  
Dispenser salviette  
carta asciugamani



**Codice 3526**  
Dispenser salviette  
carta asciugamani e  
porta guanti monouso  
In ABS cromato



**Codice 5041**  
Dispenser carta a  
srotolamento centrale  
in ABS bianco



**Codice 4725**  
Portarotolo a parete in  
acciaio inox



**Codice 2347**  
Portarotolo industriale  
da appoggio in acciaio  
inox



**Codice 2969**  
Asciugamani elettronico in  
ABS con alimentazione a  
corrente

# ACCESSORI PER LAVAMANI



Cod. 3527

Pannello in acciaio inox con predisposizione per fissaggio a muro

Utilizzabile sui lavamani per il fissaggio di dosatore di sapone e porta salviette



Cod. 3517

Dosatore di sapone e gel igienizzante inox  
Capacità: Lt. 0,80



Codice 3474

Dosatore di sapone e gel igienizzante in acciaio inox  
QUADRO  
Capacità: Lt. 0,80



Codice 3525

Dosatore di sapone e gel igienizzante  
ABS bianco  
Capacità: Lt. 0,75



Cod. 1088

Sifone 1 via da 1"1/2 con tubo scarico Ø 40 per lavamani



Cod. 3520

Dosatore di sapone e gel igienizzante  
ABS bianco  
Capacità: Lt. 0,50



Codice 3520/LT1

Dosatore di sapone e gel igienizzante  
ABS bianco  
Capacità: Lt.1

# ARTICOLI IDRAULICI



Cod. 4587

Rubinetto squadro lavatrice  
M.M. 1/2" x 3/4"



Cod. 4588

Rubinetto squadro lavatrice  
a sfera M.M. 1/2" x 3/4"



Cod. 4589

Rubinetto a 3 vie 1/2"

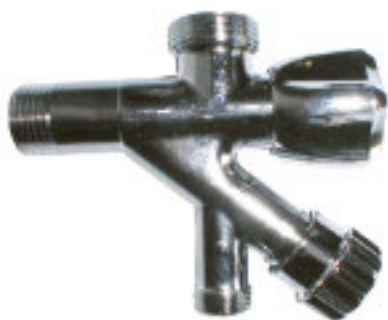

Cod. 4590

Rubinetto sottolavabo con  
attacco lavatrice 1/2"



Cod. 4591

Rubinetto con prolunga per  
gruppo lavatrice



Cod. 4592

Rubinetto sottolavabo a  
sfera 1/2" + snodo + filtro



Cod. 4593

Tappo copriforo Ø 42



Cod. 4594

Tappo copriforo pesante  
Ø 48



Cod. 4609

Rubinetto sottolavabo  
1/2 x 3/8

# ARTICOLI IDRAULICI



Rubinetto portagomma a sfera

Cod. 4595	3/8"
Cod. 4596	1/2"
Cod. 4597	3/4"
Cod. 4598	1"



Valvola a sfera M.M.

Cod. 4599	1/2" x 1/2"
Cod. 4600	3/4" x 3/4"
Cod. 4601	1" x 1"



Valvola a sfera con bocchettone

Cod. 4602	1/2"
Cod. 4603	3/4"
Cod. 4604	1"



Valvola a sfera 3 vie

Cod. 4605	3/8"
Cod. 4606	1/2"
Cod. 4607	3/4"
Cod. 4608	1"



Rubinetto mini sfera F.F.

Cod. 4638	1/8"
Cod. 4639	1/4"
Cod. 4640	3/8"
Cod. 4641	1/2"



Rubinetto mini sfera M.F.

Cod. 4642	1/8"
Cod. 4643	1/4"
Cod. 4644	3/8"
Cod. 4645	1/2"

# ARTICOLI IDRAULICI



Valvola a sfera F.F.

Cod. 4613	3/8"
Cod. 4614	1/2"
Cod. 4615	3/4"
Cod. 4616	1"
Cod. 4617	1"1/4
Cod. 4618	1"1/2
Cod. 4619	2"
Cod. 4620	2"1/2
Cod. 4621	3"
Cod. 4622	4"



Valvola a sfera M.F.

Cod. 4623	3/8"
Cod. 4624	1/2"
Cod. 4625	3/4"
Cod. 4626	1"
Cod. 4627	1"1/4
Cod. 4628	1"1/2
Cod. 4629	2"

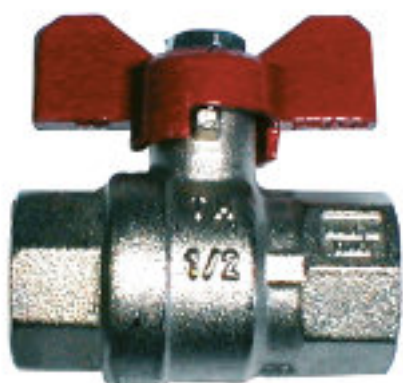

Valvola a sfera a farfalla F.F.

Cod. 4630	3/8"
Cod. 4631	1/2"
Cod. 4632	3/4"
Cod. 4633	1"



Valvola a sfera a farfalla M.F.

Cod. 4634	3/8"
Cod. 4635	1/2"
Cod. 4636	3/4"
Cod. 4637	1"

# ARTICOLI IDRAULICI



Cod. 4658

Loctite a filo mt. 50



Cod. 4610

Teflon per gas



Cod. 4611

Canapa



Cod. 4612

Pasta verde - mastice per  
raccordi filettati gr. 500



Cod. 3432

Teflon per alte temperature



Guarnizioni in gomma

Cod. 2335	1/4"
Cod. 3456	3/8"
Cod. 3455	1/2"
Cod. 3457	3/4"
Cod. 3460	1"
Cod. 1535	1"1/4
Cod. 1536	1"1/2



Cod. 4697

Guarnizioni per tubo carico



Guarnizioni per raccordi  
idraulici

Cod. 4831	3/8"
Cod. 4572	1/2"
Cod. 4573	3/4"
Cod. 4578	1"
Cod. 4780	1"1/4
Cod. 4781	1"1/2

# ARTICOLI GAS



Cod. 4656

Rubinetto GAS gomito  
M.M. 1/2"



Cod. 4657

Rubinetto GAS a sfera con  
girello 1/2" x 1/2" M.



Rubinetto GAS a  
gomito con  
portagomma Ø 14

Cod. 4660 - M. 3/8"

Cod. 4659 - M. 1/2"



Rubinetto GAS a  
gomito con  
portagomma Ø 14

Cod. 4675 - F. 1/2"



Rubinetto GAS a  
gomito F.F.

Cod. 4661 - 1/2" x 1/2"

Cod. 4662 - 3/4" x 3/4"

Cod. 4663 - 1" x 1"



Rubinetto GAS a  
gomito M.F.

Cod. 4664 - 1/2" x 1/2"



# ARTICOLI GAS



Valvola a sfera per GAS F.F.

Cod. 4678	1/4"
Cod. 4679	3/8"
Cod. 4680	1/2"
Cod. 4681	3/4"
Cod. 4682	1"
Cod. 4683	1"1/4
Cod. 4684	1"1/2
Cod. 4685	2"



Valvola a sfera per GAS M.F.

Cod. 4686	1/4"
Cod. 4687	3/8"
Cod. 4688	1/2"
Cod. 4689	3/4"
Cod. 4690	1"
Cod. 4691	1"1/4
Cod. 4692	1"1/2
Cod. 4693	2"



Rubinetto arresto GAS a sfera F.F.

Cod. 4670	1/4"
Cod. 4671	3/8"
Cod. 4672	1/2"
Cod. 4673	3/4"
Cod. 4674	1"



Rubinetto arresto GAS a sfera M.F.

Cod. 4665	1/4"
Cod. 4666	3/8"
Cod. 4667	1/2"
Cod. 4668	3/4"
Cod. 4669	1"



Cod. 4719

Regolatore bassa pressione 4 Kg.

Cod. 4720

Regolatore bassa pressione 10 Kg.



Cod. 4721

Portagomma con girello per regolatore gas bassa pressione



Cod. 4722

Portagomma fisso M. 1/2" x 10 per regolatore gas 10 kg.

Cod. 4730

Portagomma fisso M. 3/8" x 10 per regolatore gas 4 kg.

# RACCORDERIA

## IN GHISA ZINCATA



Fig. 180 Croce

Cod. 0471	3/8
Cod. 0472	1/2
Cod. 0473	3/4
Cod. 0474	1"
Cod. 0475	1"1/4
Cod. 0476	1"1/2
Cod. 0477	2"



Fig. 90 Gomito F.F.

Cod. 0434	1/4
Cod. 0435	3/8
Cod. 0436	1/2
Cod. 0437	3/4
Cod. 0438	1"
Cod. 0439	1"1/4
Cod. 0440	1"1/2
Cod. 0441	2"
Cod. 0442	2"1/2
Cod. 0443	3"
Cod. 0985	4"



Fig. 92 Gomito M.F.

Cod. 0444	1/4
Cod. 0445	3/8
Cod. 0446	1/2
Cod. 0447	3/4
Cod. 0448	1"
Cod. 0449	1"1/4
Cod. 0450	1"1/2
Cod. 0451	2"
Cod. 0452	2"1/2
Cod. 0453	3"
Cod. 0986	4"



Fig. 130 TE

Cod. 0461	1/4
Cod. 0462	3/8
Cod. 0463	1/2
Cod. 0464	3/4
Cod. 0465	1"
Cod. 0466	1"1/4
Cod. 0467	1"1/2
Cod. 0468	2"
Cod. 0469	2"1/2
Cod. 0470	3"
Cod. 0987	4"



Fig. 221 Trevie

Cod. 0479	1/2
Cod. 0480	3/4
Cod. 0481	1"
Cod. 0482	1"1/4
Cod. 0483	1"1/2
Cod. 0484	2"



Fig. 270 Manicotto

Cod. 0485	1/4
Cod. 0486	3/8
Cod. 0487	1/2
Cod. 0488	3/4
Cod. 0489	1"
Cod. 0490	1"1/4
Cod. 0491	1"1/2
Cod. 0492	2"
Cod. 0970	2"1/2
Cod. 0971	3"
Cod. 0988	4"



Fig. 529a Manicotto M.F.

Cod. 0536	3/8
Cod. 0537	1/2
Cod. 0538	3/4
Cod. 0539	1"
Cod. 0540	1"1/4
Cod. 0541	1"1/2
Cod. 0542	2"



Fig. 280 Nipples

Cod. 0493	1/4
Cod. 0494	3/8
Cod. 0495	1/2
Cod. 0496	3/4
Cod. 0497	1"
Cod. 0498	1"1/4
Cod. 0499	1"1/2
Cod. 0500	2"
Cod. 0501	2"1/2
Cod. 0502	3"
Cod. 0989	4"



Fig. 290 Tappo M.

Cod. 4373	1/4
Cod. 0503	3/8
Cod. 0504	1/2
Cod. 0505	3/4
Cod. 0506	1"
Cod. 0507	1"1/4
Cod. 0508	1"1/2
Cod. 0509	2"
Cod. 0510	2"1/2
Cod. 0511	3"
Cod. 0990	4"



Fig. 300 Tappo F.

Cod. 4374	1/4
Cod. 0512	3/8
Cod. 0513	1/2
Cod. 0514	3/4
Cod. 0515	1"
Cod. 0516	1"1/4
Cod. 0517	1"1/2
Cod. 0518	2"
Cod. 0972	2"1/2
Cod. 0973	3"
Cod. 0991	4"



Fig. 310 Controdado ghisa

Cod. 0519	1"1/4
Cod. 0520	1"1/2
Cod. 0521	2"

# RACCORDERIA

## IN GHISA ZINCATA



Fig. 245 Nipples ridotto

Cod. 0929	1/2 x 3/8
Cod. 0930	3/4 x 1/2
Cod. 0976	1" x 1/2
Cod. 0931	1" x 3/4
Cod. 2861	1"1/4 x 3/4
Cod. 0584	1"1/4 x 1"
Cod. 4091	1"1/2 x 3/4
Cod. 2862	1"1/2 x 1"
Cod. 0585	1"1/2 x 1"1/4
Cod. 2863	2" x 1"
Cod. 2864	2" x 1"1/4
Cod. 0586	2" x 1"1/2
Cod. 2865	2"1/2 x 2"
Cod. 4078	3" x 2"1/2



Fig. 241 Riduzione

Cod. 4370	3/8 x 1/4
Cod. 3941	1/2 x 1/4
Cod. 0565	1/2 x 3/8
Cod. 0566	3/4 x 1/2
Cod. 0567	3/4 x 3/8
Cod. 0568	1" x 3/8
Cod. 0569	1" x 1/2
Cod. 0570	1" x 3/4
Cod. 0571	1"1/4 x 1/2
Cod. 0572	1"1/4 x 3/4
Cod. 0573	1"1/4 x 1"
Cod. 0574	1"1/2 x 1/2
Cod. 0575	1"1/2 x 3/4
Cod. 0576	1"1/2 x 1"
Cod. 0577	1"1/2 x 1"1/4
Cod. 2887	2" x 1/2
Cod. 0578	2" x 3/4
Cod. 0579	2" x 1"
Cod. 0580	2 x 1"1/4
Cod. 0581	2 x 1"1/2
Cod. 0980	2"1/2 x 1"
Cod. 0994	2"1/2 x 1"1/4
Cod. 0993	2"1/2 x 1"1/2
Cod. 0582	2"1/2 x 2"
Cod. 0995	3" x 1"1/2
Cod. 0974	3" x 2"
Cod. 0583	3" x 2"1/2
Cod. 4385	4" x 2"
Cod. 4372	4" x 2"1/2
Cod. 0992	4" x 3"



Fig. 240 Manicotto rid. F.F.

Cod. 0558	3/8 x 1/4
Cod. 0559	1/2 x 3/8
Cod. 0560	3/4 x 1/2
Cod. 2869	1" x 1/2
Cod. 0561	1" x 3/4
Cod. 3409	1"1/4 x 3/4
Cod. 0562	1"1/4 x 1"
Cod. 2870	1"1/2 x 3/4
Cod. 2871	1"1/2 x 1"
Cod. 0563	1"1/2 x 1"1/4
Cod. 2872	2" x 1"
Cod. 2873	2" x 1"1/4
Cod. 0564	2" x 1"1/2
Cod. 2874	2"1/2 x 2"
Cod. 2875	3" x 2"
Cod. 2876	3" x 2"1/2
Cod. 3945	4" x 3"



Fig. 240 Manicotto rid. M.F.

Cod. 0587	1/2 x 3/8
Cod. 0588	3/4 x 1/2
Cod. 2866	1" x 1/2
Cod. 0589	1" x 3/4
Cod. 4379	1"1/4 x 3/4
Cod. 0590	1"1/4 x 1"
Cod. 2867	1"1/2 x 1"
Cod. 0591	1"1/2 x 1"1/4
Cod. 4059	2" x 1"
Cod. 2868	2" x 1"1/4
Cod. 0592	2" x 1"1/2



Fig. 130r TE ridotto

Cod. 0547	3/8 x 1/2 x 3/8
Cod. 0548	1/2 x 3/8 x 3/8
Cod. 0549	1/2 x 3/8 x 1/2
Cod. 0550	1/2 x 1/2 x 3/8
Cod. 0551	1/2 x 3/4 x 1/2
Cod. 0552	3/4 x 1/2 x 1/2
Cod. 0553	3/4 x 1/2 x 3/4
Cod. 0554	3/4 x 3/4 x 1/2
Cod. 3406	3/4 x 1" x 3/4
Cod. 3407	1" x 1/2 x 1/2
Cod. 4067	1" x 1/2 x 1"
Cod. 0555	1" x 3/4 x 3/4
Cod. 0556	1" x 3/4 x 1"
Cod. 0557	1" x 1" x 3/4
Cod. 3374	1"1/4 x 1" x 1"1/4
Cod. 3389	1"1/2 x 3/4 x 1"1/2
Cod. 3375	1"1/2 x 1" x 1"1/2
Cod. 3391	2" x 3/4 x 2"
Cod. 3390	2" x 1" x 2"



Fig. 90r Gomito ridotto F.F.

Cod. 0543	1/2 x 3/8
Cod. 0544	3/4 x 1/2
Cod. 4075	1" x 1/2
Cod. 0545	1" x 3/4
Cod. 0546	1"1/4 x 1"
Cod. 4079	1"1/2 x 1"
Cod. 4074	1"1/2 x 1"1/4



Fig. 341 Bocchettone diritto M.F.

Cod. 0522	3/8
Cod. 0523	1/2
Cod. 0524	3/4
Cod. 0525	1"
Cod. 0526	1"1/4
Cod. 0527	1"1/2
Cod. 0528	2"
Cod. 0528/SP	2" sede piana
Cod. 4333	2"1/2 sede piana
Cod. 4387	2"1/2 sede conica
Cod. 4334	3" sede piana
Cod. 4388	3" sede conica
Cod. 4389	4" sede conica



Fig. 340 Bocch. diritto F.F.

Cod. 0529	3/8
Cod. 0530	1/2
Cod. 0531	3/4
Cod. 0532	1"
Cod. 0533	1"1/4
Cod. 0534	1"1/2
Cod. 0535	2"
Cod. 3740	4" sede piana



Fig. 98 Bocchettone curvo M.F.

Cod. 0454	3/8
Cod. 0455	1/2
Cod. 0456	3/4
Cod. 0457	1"
Cod. 0458	1"1/4
Cod. 0459	1"1/2
Cod. 0460	2"



Fig. 96 Bocchettone curvo F.F.

Cod. 0454FF	3/8
Cod. 0455FF	1/2
Cod. 0456FF	3/4
Cod. 0457FF	1"
Cod. 0458FF	1"1/4
Cod. 0459FF	1"1/2
Cod. 0460FF	2"

# RACCORDERIA

## IN GHISA ZINCATA



Fig. 2 Curva 90° F.F.

Cod. 0940	1/2
Cod. 0941	3/4
Cod. 0942	1"
Cod. 0943	1"1/4
Cod. 3932	2"



Fig. 41 Curva 45° F.F.

Cod. 0940/45	1/2
Cod. 0941/45	3/4
Cod. 0942/45	1"
Cod. 0943/45	1"1/4



Fig. 1 Curva 90° M.F.

Cod. 0944	1/2
Cod. 0945	3/4
Cod. 0946	1"
Cod. 0947	1"1/4
Cod. 3931	2"



Fig. 40 Curva 45° M.F.

Cod. 0944/45	1/2
Cod. 0945/45	3/4
Cod. 0946/45	1"
Cod. 0947/45	1"1/4

# RACCORDERIA

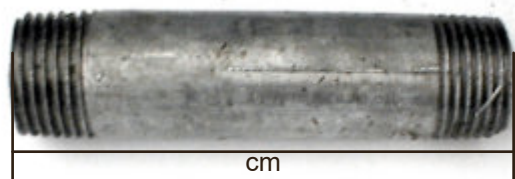

Tronchetto zincato 2 Fil.

Cod. 0773	3/8 x 6 cm
Cod. 0774	3/8 x 8 cm
Cod. 0775	3/8 x 10 cm
Cod. 0776	3/8 x 12 cm
Cod. 2886	3/8 x 20 cm
Cod. 4100	3/8 x 30 cm
Cod. 3343	3/8 x 200 cm
Cod. 0777	1/2 x 6 cm
Cod. 0778	1/2 x 8 cm
Cod. 0779	1/2 x 10 cm
Cod. 0780	1/2 x 12 cm
Cod. 0955	1/2 x 20 cm
Cod. 2279	1/2 x 30 cm
Cod. 2291	1/2 x 60 cm
Cod. 2282	1/2 x 100 cm
Cod. 2285	1/2 x 150 cm
Cod. 2288	1/2 x 200 cm
Cod. 0781	3/4 x 6 cm
Cod. 0782	3/4 x 8 cm
Cod. 0783	3/4 x 10 cm
Cod. 0784	3/4 x 12 cm
Cod. 0956	3/4 x 20 cm
Cod. 2280	3/4 x 30 cm
Cod. 2292	3/4 x 60 cm
Cod. 2283	3/4 x 100 cm
Cod. 2286	3/4 x 150 cm
Cod. 2289	3/4 x 200 cm
Cod. 0785	1" x 6 cm
Cod. 0786	1" x 8 cm
Cod. 0787	1" x 10 cm
Cod. 0788	1" x 12 cm
Cod. 0957	1" x 20 cm
Cod. 2281	1" x 30 cm
Cod. 2293	1" x 60 cm
Cod. 2284	1" x 100 cm
Cod. 2287	1" x 150 cm
Cod. 2290	1" x 200 cm
Cod. 0954	1"1/4 x 10 cm
Cod. 0958	1"1/4 x 20 cm
Cod. 2210	1"1/4 x 30 cm
Cod. 4080	1"1/4 x 60 cm
Cod. 4081	1"1/4 x 100 cm
Cod. 4082	1"1/4 x 150 cm
Cod. 4083	1"1/4 x 200 cm
Cod. 3711	1"1/2 x 6 cm
Cod. 2884	1"1/2 x 10 cm
Cod. 3399	1"1/2 x 12 cm
Cod. 4384	1"1/2 x 20 cm
Cod. 1288	1"1/2 x 30 cm
Cod. 4084	1"1/2 x 60 cm
Cod. 4085	1"1/2 x 100 cm
Cod. 4086	1"1/2 x 150 cm
Cod. 4087	1"1/2 x 200 cm
Cod. 3951	2" x 6 cm
Cod. 2885	2" x 10 cm
Cod. 3398	2" x 12 cm
Cod. 4397	2" x 20 cm
Cod. 4096	2" x 30 cm
Cod. 4097	2" x 60 cm
Cod. 4088	2" x 100 cm
Cod. 4089	2" x 150 cm
Cod. 4090	2" x 200 cm
Cod. 0824	2"1/2 x 8 cm
Cod. 3723	2"1/2 x 10 cm
Cod. 3943	2"1/2 x 12 cm
Cod. 3944	2"1/2 x 20 cm
Cod. 3392	2"1/2 x 30 cm



Tronchetto zinc. 2 filetti con 1 filettatura lunga

Cod. 4102	3/8 x 10 cm
Cod. 0789	1/2 x 10 cm
Cod. 0790	3/4 x 10 cm
Cod. 0791	1" x 10 cm
Cod. 0792	1"1/4 x 10 cm
Cod. 3402	1"1/4 x 15 cm



Tronchetto nero 2 Fil.

Cod. 0753	3/8 x 10 cm
Cod. 0763	3/8 x 20 cm
Cod. 0754	1/2 x 10 cm
Cod. 0764	1/2 x 20 cm
Cod. 0755	3/4 x 10 cm
Cod. 0765	3/4 x 20 cm
Cod. 4057	3/4 x 30 cm
Cod. 0756	1" x 10 cm
Cod. 0766	1" x 20 cm
Cod. 4054	1" x 30 cm
Cod. 0757	1"1/4 x 10 cm
Cod. 0767	1"1/4 x 20 cm
Cod. 0758	1"1/2 x 10 cm
Cod. 0768	1"1/2 x 20 cm
Cod. 0759	2" x 10 cm
Cod. 0769	2" x 20 cm
Cod. 0760	2"1/2 x 10 cm
Cod. 0770	2"1/2 x 20 cm
Cod. 0761	3" x 10 cm
Cod. 0771	3" x 20 cm
Cod. 0762	4" x 10 cm
Cod. 0772	4" x 20 cm



Manicotto ferro nero

Cod. 0729	1/8
Cod. 0730	1/4
Cod. 0731	3/8
Cod. 0732	1/2
Cod. 0733	3/4
Cod. 0734	1"
Cod. 0735	1"1/4
Cod. 0736	1"1/2
Cod. 0737	2"
Cod. 0739	2"1/2
Cod. 0740	3"
Cod. 0741	4"
Cod. 4377	5"



Tronchetto nero 1 Fil.

Cod. 0742	3/8 x 10 cm
Cod. 4076	3/8 x 15 cm
Cod. 0743	1/2 x 10 cm
Cod. 0744	3/4 x 10 cm
Cod. 0745	1" x 10 cm
Cod. 3394	1" x 15 cm
Cod. 0746	1"1/4 x 10 cm
Cod. 0747	1"1/2 x 10 cm
Cod. 0703	1"1/2 x 15 cm
Cod. 2081	1"1/2 x 20 cm
Cod. 4098	1"1/2 x 30 cm
Cod. 0748	2" x 10 cm
Cod. 0749	2"1/2 x 10 cm
Cod. 0750	3" x 10 cm
Cod. 4060	3" x 12 cm
Cod. 2080	3" x 15 cm
Cod. 4061	3" x 20 cm
Cod. 0752	4" x 10 cm
Cod. 4376	5" x 10 cm
Cod. 4124	6" x 10 cm



Curva nera a saldare

Cod. 0719	1/2
Cod. 0720	3/4
Cod. 0721	1"
Cod. 0722	1"1/4
Cod. 0723	1"1/2
Cod. 0724	2"
Cod. 0725	2"1/2
Cod. 0726	3"
Cod. 0727	3"1/2
Cod. 0728	4"
Cod. 4064	5"
Cod. 4399	6"

# RACCORDERIA IN FERRO ZINCATO



Prolunga A. zincato M.F.

Cod. 4103	1/4 x 10
Cod. 0614	3/8 x 10
Cod. 0615	3/8 x 15
Cod. 0616	3/8 x 20
Cod. 0617	3/8 x 30
Cod. 0618	3/8 x 40
Cod. 4322	3/8 x 50
Cod. 0619	1/2 x 10
Cod. 0620	1/2 x 15
Cod. 0621	1/2 x 20
Cod. 0622	1/2 x 25
Cod. 0623	1/2 x 30
Cod. 0624	1/2 x 40
Cod. 0625	1/2 x 50
Cod. 0626	3/4 x 10
Cod. 0926	3/4 x 15
Cod. 0627	3/4 x 20
Cod. 4323	3/4 x 30
Cod. 4324	3/4 x 40
Cod. 4325	3/4 x 50
Cod. 0628	1" x 10
Cod. 4101	1" x 15
Cod. 0629	1" x 20
Cod. 4319	1" x 30
Cod. 4320	1" x 40
Cod. 4321	1" x 50



Prolunga rid. A. zincato M.F.

Cod. 0630	1/4 x 1/8
Cod. 0631	3/8 x 1/4
Cod. 2889	1/2 x 1/4
Cod. 0632	1/2 x 3/8
Cod. 4055	3/4 x 3/8
Cod. 0633	3/4 x 1/2
Cod. 2888	1" x 1/2
Cod. 0634	1" x 3/4



Prolunga A. Zincato

Cod. 0635	3/8F x 1/2M
Cod. 0598	1/2F x 3/4M



Prolunga rid. A. zincato F.F.

Cod. 0969	1/4 x 1/8
Cod. 0636	3/8 x 1/4
Cod. 2890	1/2 x 1/4
Cod. 0637	1/2 x 3/8
Cod. 4070	3/4 x 3/8
Cod. 0638	3/4 x 1/2
Cod. 4068	1"x3/8
Cod. 4069	1"x1/2
Cod. 0639	1" x 3/4



Nipples rid. A. zincato

Cod. 0646	1/4 x 1/8
Cod. 3403	3/8x1/8
Cod. 0647	3/8 x 1/4
Cod. 3378	1/2 x 1/8
Cod. 0594	1/2 x 1/4
Cod. 0648	1/2 x 3/8
Cod. 0593	3/4 x 3/8
Cod. 0649	3/4 x 1/2
Cod. 0961	1" x 1/2
Cod. 0650	1" x 3/4



Riduzione A. zincato

Cod. 0651	1/4 x 1/8
Cod. 2892	3/8 x 1/8
Cod. 0652	3/8 x 1/4
Cod. 2891	1/2 x 1/8
Cod. 0653	1/2 x 1/4
Cod. 0654	1/2 x 3/8
Cod. 2893	3/4 x 1/4
Cod. 0655	3/4 x 3/8
Cod. 0656	3/4 x 1/2
Cod. 0657	1" x 3/8
Cod. 0658	1" x 1/2
Cod. 0659	1" x 3/4



Tappo M. A. zincato

Cod. 0660	1/8
Cod. 0661	1/4
Cod. 0662	3/8
Cod. 0663	1/2
Cod. 0664	3/4
Cod. 0665	1"



Nipples D. A. zincato

Cod. 0640	1/8
Cod. 0641	1/4
Cod. 0642	3/8
Cod. 0643	1/2
Cod. 0644	3/4
Cod. 0645	1"



Nipples liscio A. zincato

Cod. 0599	1/8
Cod. 0597	1/4
Cod. 0679	3/8
Cod. 0680	1/2
Cod. 0681	3/4
Cod. 0682	1"
Cod. 0683	1"1/4
Cod. 0684	1"1/2
Cod. 0685	2"



Controdado A. zincato

Cod. 0666	1/8
Cod. 0667	1/4
Cod. 0668	3/8
Cod. 0669	1/2
Cod. 0670	3/4
Cod. 0671	1"
Cod. 0672	1"1/4
Cod. 4381	1"1/2



Tappo F. A. zincato

Cod. 0673	1/8
Cod. 0674	1/4
Cod. 0675	3/8
Cod. 0676	1/2
Cod. 0677	3/4
Cod. 0678	1"

Manicotto A. zincato F.F.

Cod. 0964	1/8
Cod. 0965	1/4
Cod. 0966	3/8
Cod. 0967	1/2
Cod. 0978	3/4
Cod. 0977	1"
Cod. 2878	1"1/4
Cod. 2879	1"1/2
Cod. 2880	2"
Cod. 2881	2"1/2
Cod. 2882	3"
Cod. 2883	4"
Cod. 4072	5"

# RACCORDERIA IN ACCIAIO INOX AISI316



Tappo M. acciaio inox

Cod. 2413	1/4
Cod. 2419	3/8
Cod. 2420	1/2
Cod. 2416	3/4
Cod. 2421	1"



Tappo F. acciaio inox

Cod. 2042	1/4
Cod. 5051	3/8
Cod. 2044	1/2
Cod. 2045	3/4
Cod. 4139	1"



Nipples acciaio inox

Cod. 2095	1/4
Cod. 2096	3/8
Cod. 2097	1/2
Cod. 2098	3/4
Cod. 2099	1"



Nipples rid. acciaio inox

Cod. 2409	3/8 x 1/4
Cod. 2410	1/2 x 3/8
Cod. 2411	3/4 x 1/2
Cod. 2412	1" x 3/4



Gomito M.F. acciaio inox

Cod. 2909	1/4
Cod. 2910	3/8
Cod. 2414	1/2
Cod. 2911	3/4
Cod. 2912	1"



Gomito F.F. acciaio inox

Cod. 4361	1/4
Cod. 3930	3/8
Cod. 2907	1/2
Cod. 2418	3/4
Cod. 2908	1"



TE acciaio inox

Cod. 2927	1/4
Cod. 2928	3/8
Cod. 2417	1/2
Cod. 3947	3/4
Cod. 2929	1"



Manicotto acciaio inox

Cod. 2801	1/4
Cod. 2802	3/8
Cod. 2803	1/2
Cod. 2804	3/4
Cod. 2805	1"



Riduzione acciaio inox

Cod. 2446	3/8 x 1/4
Cod. 2447	1/2 x 3/8
Cod. 2415	3/4 x 1/2
Cod. 2448	1" x 3/4



Portagomma fisso  
acciaio inox M.

Cod. 4362	1/4 x 10
-----------	----------

# RACCORDERIA IN OTTONE GIALLO



TE ottone giallo

Cod. 2211	1/4
Cod. 2212	3/8
Cod. 2213	1/2
Cod. 2214	3/4
Cod. 2215	1"
Cod. 4343	1"1/4
Cod. 4346	1"1/2
Cod. 4347	2"



Gomito F.F. ottone giallo

Cod. 2216	1/4
Cod. 2217	3/8
Cod. 2218	1/2
Cod. 2219	3/4
Cod. 2220	1"
Cod. 4341	1"1/4
Cod. 4348	1"1/2
Cod. 4349	2"



Gomito M.F. ottone giallo

Cod. 2221	1/4
Cod. 2222	3/8
Cod. 2223	1/2
Cod. 2224	3/4
Cod. 2225	1"
Cod. 4342	1"1/4
Cod. 4350	1"1/2
Cod. 4351	2"



Nipples ottone giallo

Cod. 2226	1/8
Cod. 2227	1/4
Cod. 2228	3/8
Cod. 2229	1/2
Cod. 2230	3/4
Cod. 2231	1"
Cod. 4301	1"1/4
Cod. 4339	1"1/2
Cod. 4340	2"



Tappo M. ottone giallo

Cod. 2242	1/8
Cod. 2243	1/4
Cod. 2244	3/8
Cod. 2245	1/2
Cod. 2246	3/4
Cod. 2247	1"
Cod. 4358	1"1/4
Cod. 4359	1"1/2
Cod. 4360	2"



Tappo F. ottone giallo

Cod. 2248	3/8
Cod. 2249	1/2
Cod. 2250	3/4
Cod. 2251	1"
Cod. 4363	1"1/4
Cod. 4364	1"1/2
Cod. 4365	2"



Manicotto ottone giallo

Cod. 2232	1/8
Cod. 2233	1/4
Cod. 2234	3/8
Cod. 2235	1/2
Cod. 2236	3/4
Cod. 2237	1"
Cod. 4302	1"1/4
Cod. 4352	1"1/2
Cod. 4353	2"



Manicotto M.F. ottone giallo

Cod. 1412	1"1/4
Cod. 1414	1"1/2



Manicotto rid. ottone giallo

Cod. 2266	1/2 x 3/8
Cod. 2267	3/4 x 1/2
Cod. 2268	1" x 3/4
Cod. 4303	1"1/4 x 1"
Cod. 2113	1"1/2 x 1"
Cod. 4367	1"1/2 x 1"1/4
Cod. 2091	2" x 1"
Cod. 2112	2" x 1"1/4
Cod. 4368	2" x 1"1/2



Prolunga rid. ottone giallo

Cod. 2269	3/8 x 1/4
Cod. 3732	3/8 x 3/4
Cod. 2270	1/2 x 3/8
Cod. 2271	3/4 x 1/2
Cod. 2272	1" x 3/4
Cod. 3420	1"1/4 x 1"
Cod. 0427	1/2M x 3/8F
Cod. 0426	3/4M x 1/2F
Cod. 4306	1" M x 3/4F
Cod. 3425	1"1/4M x 1" F
Cod. 1279	1"1/2 M x 1"F



Riduzione ottone giallo

Cod. 2262	3/8 x 1/4
Cod. 3935	1/2 x 1/4
Cod. 2263	1/2 x 3/8
Cod. 3411	3/4x3/8
Cod. 2264	3/4 x 1/2
Cod. 4315	1" x 1/2
Cod. 2265	1" x 3/4
Cod. 4304	1"1/4 x 1"
Cod. 4356	1"1/4 x 3/4
Cod. 3426	1"1/2 x 3/4
Cod. 4328	1"1/2 x 1"1/4
Cod. 4354	1"1/2 x 1"
Cod. 4337	2" x 1/2
Cod. 4357	2" x 1"
Cod. 4355	2" x 1"1/4
Cod. 4329	2" x 1"1/2



# RACCORDERIA IN OTTONE GIALLO



Nipples liscio

Cod. 3427	1/2 mm 30
Cod. 3427-4	1/2 mm 40



Tronchetto ottone giallo 2 fil.

Cod. 0428	1/2 x 4
Cod. 0429	1/2 x 5
Cod. 4327	1/2 x 6
Cod. 4392	1/2 x 8
Cod. 4300	1/2 x 10
Cod. 3418	1/2 x 15
Cod. 4393	1/2x20
Cod. 3936	3/4 x 6
Cod. 3937	3/4 x 8
Cod. 4332	3/4x10
Cod. 3419	3/4 x 15
Cod. 3423	3/4 x 20

Nipples rid. ottone giallo

Cod. 2273	3/8 x 1/4
Cod. 2186	1/2 x 1/4
Cod. 2274	1/2 x 3/8
Cod. 3439	3/4 x 3/8
Cod. 2275	3/4 x 1/2
Cod. 3413	1"x1/2
Cod. 2276	1" x 3/4
Cod. 3410	1"1/4 x 3/4
Cod. 4305	1"1/4 x 1"
Cod. 3414	1"1/2 x 1"
Cod. 4369	1"1/2 x 1"1/4
Cod. 4338	2" x 1"
Cod. 3431	2" x 1"1/4
Cod. 4331	2" x 1"1/2



Croce ottone giallo

Cod. 3395	3/8
Cod. 4395	1/2
Cod. 4093	3/4
Cod. 4094	1"



Controdado ottone giallo

Cod. 2238	3/8
Cod. 2239	1/2
Cod. 2240	3/4
Cod. 2241	1"
Cod. 4366	1"1/4
Cod. 3421	1"1/2
Cod. 4095	2"



Prolunga ottone giallo

Cod. 2252	3/8 x 10
Cod. 2253	3/8 x 15
Cod. 2254	3/8 x 20
Cod. 2255	1/2 x 10
Cod. 2256	1/2 x 15
Cod. 2257	1/2 x 20
Cod. 2278	1/2 x 25
Cod. 2258	1/2 x 30
Cod. 2259	3/4 x 10
Cod. 2260	3/4 x 15
Cod. 2261	3/4 x 20
Cod. 0907	3/4 x 30
Cod. 4307	1" x 10
Cod. 4308	1" x 15
Cod. 4309	1" x 20



TE M. 3/4 x M. 3/4 x M. 3/4

Cod. 3422



Controdado base larga ottone giallo

Cod. 3393	1/2
Cod. 3424	3/4
Cod. 3862	1"
Cod. 3096	1"1/4
Cod. 3097	1"1/2
Cod. 3098	2"

# RACCORDERIA IN OTTONE GIALLO



Portagomma fisso M.

Cod. 0694	1/8 x 10
Cod. 0695	1/4 x 10
Cod. 0696	1/4 x 14
Cod. 0697	3/8 x 10
Cod. 0698	3/8 x 14
Cod. 0699	1/2 x 10
Cod. 4394	1/2 x 12
Cod. 0700	1/2 x 14
Cod. 0904	1/2 x 16
Cod. 0919	1/2 x 18
Cod. 0905	1/2 x 20
Cod. 4123	3/4 x 14
Cod. 3429	3/4 x 16
Cod. 0701	3/4 x 18
Cod. 0702	3/4 x 20
Cod. 0920	3/4 x 25
Cod. 4056	1" x 20
Cod. 0704	1" x 25
Cod. 0705	1" x 30
Cod. 0715	1"1/4 x 30
Cod. 1275	1"1/4 x 35
Cod. 0600	1"1/4 x 40
Cod. 0716	1"1/2 x 40
Cod. 1276	1"1/2 x 45
Cod. 0601	1"1/2 x 50
Cod. 0718	2" x 50
Cod. 0602	2" x 60
Cod. 0962	2"1/2 x 60
Cod. 0963	3" x 80



Portagomma fisso F.

Cod. 4066	1/8 x 10
Cod. 0706	1/4 x 10
Cod. 0707	1/4 x 14
Cod. 0708	3/8 x 10
Cod. 0709	3/8 x 14
Cod. 0710	1/2 x 10
Cod. 0711	1/2 x 14
Cod. 0906	1/2 x 18
Cod. 4065	1/2 x 20
Cod. 0712	3/4 x 20
Cod. 0932	3/4 x 25
Cod. 0713	1" x 25
Cod. 0714	1" x 30
Cod. 0933	1"1/4 x 30
Cod. 1277	1"1/4 x 35
Cod. 0934	1"1/2 x 40
Cod. 0595	2" x 50



Portagomma ott. curvo F.

Cod. 2857	3/8 x 10
Cod. 2858	3/8 x 14 fil.
Cod. 2859	1/2 x 10
Cod. 2860	1/2 x 14 fil.



Portagomma ott. curvo M.

Cod. 0793	3/8 x 10
Cod. 0794	3/8 x 14 fil.
Cod. 0909	1/2 x 10
Cod. 2856	1/2 x 14 fil.



Tappo M. con rosetta

Cod. 0688	3/8
Cod. 0689	1/2



Bocchettone ottone dritto

Cod. 0604	3/8
Cod. 0605	1/2
Cod. 0606	3/4
Cod. 0607	1"
Cod. 0608	1"1/4
Cod. 0927	1"1/2
Cod. 0935	2"



Bocchettone ottone gomito

Cod. 0609	3/8
Cod. 0610	1/2
Cod. 0611	3/4
Cod. 0612	1"
Cod. 0613	1"1/4
Cod. 0928	1"1/2
Cod. 0979	2"



Ghiera ottone

Cod. 0686	1/2 x 3/8
Cod. 0687	3/4 x 1/2
Cod. 4396	1" x 1/2
Cod. 0968	1" x 3/4

# RACCORDERIA IN OTTONE CROMATO



Portagomma fisso M. ottone cromato	
Cod. 2730	1/8 x 10
Cod. 2731	1/8 x 14
Cod. 2732	1/4 x 10
Cod. 2733	1/4 x 14
Cod. 2734	3/8 x 10
Cod. 2735	3/8 x 14
Cod. 2736	1/2 x 10
Cod. 2737	1/2 x 14



Portagomma fisso F. ottone cromato	
Cod. 2738	1/8 x 10
Cod. 2739	1/8 x 14
Cod. 2740	1/4 x 10
Cod. 2741	1/4 x 14
Cod. 2742	3/8 x 10
Cod. 2743	3/8 x 14
Cod. 2744	1/2 x 10
Cod. 2745	1/2 x 14



Tappo F. ottone cromato	
Cod. 2746	1/8
Cod. 2747	1/4
Cod. 2748	3/8
Cod. 2749	1/2
Cod. 3397	3/4



Tappo M. ottone cromato	
Cod. 2750	1/8
Cod. 2751	1/4
Cod. 2752	3/8
Cod. 2753	1/2
Cod. 3400	3/4



Controdado ottone cromato	
Cod. 2754	1/8
Cod. 2755	1/4
Cod. 2756	3/8
Cod. 2757	1/2



Nipples rid. ottone cromato	
Cod. 2758	1/4 x 1/8
Cod. 2759	3/8 x 1/4
Cod. 2760	1/2 x 3/8
Cod. 4311	3/4 x 1/2



Nipples ottone cromato	
Cod. 2761	1/8
Cod. 2762	1/4
Cod. 2763	3/8
Cod. 2764	1/2
Cod. 4312	3/4
Cod. 3401	1"



Riduzione ottone cromato	
Cod. 2765	1/4 x 1/8
Cod. 3408	3/8 x 1/8
Cod. 2766	3/8 x 1/4
Cod. 3342	1/2 x 1/4
Cod. 2767	1/2 x 3/8
Cod. 4345	3/4 x 1/2



Ghiera ottone cromato	
Cod. 2768	3/8 x 1/4
Cod. 2769	1/2 x 3/8

# RACCORDERIA IN OTTONE CROMATO



Manicotto ottone cromato

Cod. 2770	1/8
Cod. 2771	1/4
Cod. 2772	3/8
Cod. 2773	1/2
Cod. 4316	3/4



Prolunga rid. F.F.  
ottone cromato

Cod. 2774	1/2 x 3/8
Cod. 4310	3/4 x 1/2



Prolunga rid. ottone cromato

Cod. 2775	F. 1/4 x 1/8 M.
Cod. 2776	F. 3/8 x 1/4 M.
Cod. 2777	F. 1/2 x 3/8 M.
Cod. 2852	F. 3/4 x 1/2 M.



Gomito F.F. ottone cromato

Cod. 2781	1/4
Cod. 2782	3/8
Cod. 2783	1/2
Cod. 4314	3/4



Gomito M.F. ottone cromato

Cod. 2784	1/4
Cod. 2785	3/8
Cod. 2786	1/2
Cod. 4317	3/4
Cod. 4335	1"



Gomito M.M.  
ottone cromato

Cod. 2877	1/2
-----------	-----



TE ottone cromato

Cod. 2778	1/4
Cod. 2779	3/8
Cod. 2780	1/2
Cod. 4318	3/4



Prolunga ottone cromato

Cod. 2787	3/8 x 10
Cod. 2788	3/8 x 15
Cod. 2789	3/8 x 20
Cod. 2790	3/8 x 30
Cod. 2791	1/2 x 10
Cod. 2792	1/2 x 15
Cod. 2793	1/2 x 20
Cod. 2794	1/2 x 30
Cod. 2795	1/2 x 40
Cod. 4313	3/4 x 15
Cod. 4344	3/4 x 20

## CONDIZIONI DI VENDITA

Le forniture si effettuano esclusivamente in base alle seguenti disposizioni, che s'intendono tacitamente approvate con l'ordinazione ed in particolare con l'accettazione delle nostre offerte, conferme e fatture. Altre condizioni si ritengono valide soltanto se da noi confermate espressamente.

Modelli, colori, dimensioni e descrizioni contenuti nel catalogo sono indicativi e l'aspetto del materiale può essere diverso da quello mostrato nelle fotografie.

Tassinari Rubinetterie S.r.l. si riserva il diritto di apportare, senza preavviso, in qualsiasi momento e per qualsiasi motivo, tutte le modifiche ritenute opportune.

E' vietata qualsiasi riproduzione, anche parziale, se non autorizzata.

La violazione sarà perseguita a norma di legge.

### PREZZI

I prezzi indicati nelle offerte e listino sono al netto dell'I.V.A. e possono essere mantenuti tali soltanto se la qualità e quantità menzionate nell'offerta rimangono invariate.

I prezzi sono calcolati in base ai costi esistenti il giorno della presentazione dell'offerta ed in caso di sostanziali mutamenti delle circostanze, ad essi inerenti, possono venir adattati in conformità anche per ordini da evadere ancora parzialmente.

### INVIO, SPESE DI SPEDIZIONE

La fornitura della merce si effettua franco partenza. La spedizione viene eseguita secondo le disposizioni dell'ordinante, in mancanza di queste, col mezzo ritenuto più idoneo.

### TERMINI DI CONSEGNA

E' nostra premura rispettare i termini di consegna comunicati, cerchiamo con il massimo impegno di evadere nel più breve tempo possibile ogni ordine.

Tuttavia i termini di consegna si intendono approssimativi e non impegnativi essendo vincolati alla possibilità del momento e da eventuali imprevisti.

La mancata osservanza da parte nostra di detti termini non dà diritto al cliente di annullare l'ordine, differire pagamenti o reclamare indennizzi, compensi, penali o danni di sorta.

Quanto sopra vale anche nei casi in cui la mancata osservanza dei termini di consegna è conseguente a ritardi nei trasporti, smarrimento dei colli da parte del corriere, serrate, incendio ecc

### PAGAMENTO

I termini di pagamento specificati in fattura si intendono tassativi: ogni variazione, che non sia stata preventivamente ed espressamente pattuita, verrà respinta.

Ci riserviamo infine di sospendere le consegne o annullare eventuali ordini già accettati, qualora i pagamenti non siano effettuati nei termini convenuti.

Nessuna contestazione, per ritardi di consegna, vizi e difetti, potrà essere sollevata da chi non è in regola con i pagamenti convenuti e la stessa non dà diritto a sospendere i pagamenti.

I pagamenti effettuati oltre al termine convenuto possono dar luogo all'addebito degli interessi di mora.

### RISCHI

La merce viaggia a rischio e pericolo del committente, anche se la spedizione è effettuata in porto franco.

Non si accettano reclami se non fatti entro otto giorni dal ricevimento della merce.

La verifica della merce deve essere fatta dal compratore alla consegna. Al momento dello scarico controllare sempre l'integrità ed il numero dei colli, non si accettano reclami relativi a rotture o mancanza di merce successivamente allo scarico.

Eventuali resi devono essere preventivamente autorizzati ed effettuati in porto franco.

### GARANZIA

La nostra responsabilità sulla qualità del materiale si limita, previa nostra autorizzazione, ad accettare il reso, in porto franco, di pezzi riscontrati difettosi, per disporre la sostituzione, senza essere tenuti a corrispondere alcun indennizzo.

Non possiamo inoltre accettare alcuna responsabilità ove i materiali da noi forniti risultassero manomessi.

Ci riserviamo di non ricevere la merce di ritorno, se la restituzione non sarà da noi preventivamente autorizzata, oppure se la resa non verrà effettuata secondo le modalità di spedizione da noi stabilite.

Oltre a ciò rimane esclusa ogni e qualsiasi responsabilità per tutte le conseguenze derivanti dall'impegno ed installazione dei nostri materiali e non riconosceremo alcuna spesa di mano d'opera per la sostituzione di articoli difettosi, così nulla sarà dovuto a titolo di risarcimento per danni diretti o indiretti, subiti o insorti.

### FORO

Per tutte le controversie che dovessero sorgere è unicamente competente l'autorità giudiziaria di Forlì.





**TASSINARI**  
**RUBINETTERIE SRL**

<http://ordini.tassinarirubinetterie.com>



*Tassinari Rubinetterie Srl*

Via Calcinaro 2107

47521 Cesena (FC) - Italy

Tel. +39 0547/380667

Fax +39 0547/635063

Email: [info@tassinarirubinetterie.com](mailto:info@tassinarirubinetterie.com)

Web site: [www.tassinarirubinetterie.it](http://www.tassinarirubinetterie.it)

Area Riservata: <http://ordini.tassinarirubinetterie.com>

